



Operator's Manual

Serial Number Range

Z-80/60

from 3158

AUS
Australia

with
Maintenance
Information

Sixth Edition
Sixth Printing
Part No. 226482

Important

Read, understand and obey these safety rules and operating instructions before operating this machine. Only trained and authorized personnel shall be permitted to operate this machine. This manual should be considered a permanent part of your machine and should remain with the machine at all times. If you have any questions, contact us.

Contact Us:

Internet: www.genielift.com

E-mail: awp.techpub@terex.com

Contents

- Introduction 1
- Symbol and Hazard Pictorials Definitions..... 3
- Personal Safety..... 5
- Personal Safety..... 9
- Work Area Safety..... 10
- Legend 20
- Controls..... 21
- Inspections..... 29
- Operating Instructions..... 42
- Transport and Lifting Instructions 54
- Maintenance 57
- Specifications..... 61

Copyright © 2002 by Terex Corporation

Sixth Edition: Sixth Printing, May 2017

Genie and "Z" are registered trademarks of Terex South Dakota, Inc. in the U.S.A. and many other countries.

These machines comply with AS 1418.10

Introduction

Owners, Users and Operators:

Thank you for choosing our machine for your application. Our number one priority is user safety, which is best achieved by our joint efforts. We feel that you make a major contribution to safety if you, as the equipment users and operators:

- 1 **Comply** with employer, job site and governmental rules.
- 2 **Read, understand and follow** the instructions in this and other manuals supplied with this machine.
- 3 **Use good safe work practices** in a commonsense way.
- 4 **Only have trained/certified operators**, directed by informed and knowledgeable supervision, running the machine.



Danger

Failure to obey the instructions and safety rules in this manual will result in death or serious injury.

Do Not Operate Unless:

- You learn and practice the principles of safe machine operation contained in this operator's manual.
 - 1 **Avoid hazardous situations.**
Know and understand the safety rules before going on to the next section.
 - 2 Always perform a pre-operation inspection.
 - 3 Always perform function tests prior to use.
 - 4 Inspect the workplace.
 - 5 Only use the machine as it was intended.
- You read, understand and obey the manufacturer's instructions and safety rules—safety and operator's manuals and machine decals.
- You read, understand and obey employer's safety rules and worksite regulations.
- You read, understand and obey all applicable governmental regulations.
- You are properly trained to safely operate the machine.

Introduction

Hazard Classification

Decals on this machine use symbols, color coding and signal words to identify the following:



Safety alert symbol—used to alert you to potential personal injury hazards. Obey all safety messages that follow this symbol to avoid possible injury or death.

⚠ DANGER

Indicates a hazardous situation which, if not avoided, will result in death or serious injury.

⚠ WARNING

Indicates a hazardous situation which, if not avoided, could result in death or serious injury.

⚠ CAUTION

Indicates a hazardous situation which, if not avoided, could result in minor or moderate injury.

NOTICE

Indicates a property damage message.















Intended Use

This machine is intended to be used only to lift personnel, along with their tools and materials to an aerial work site.

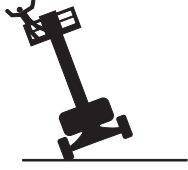

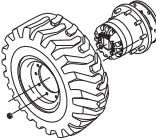



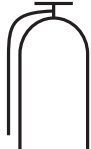

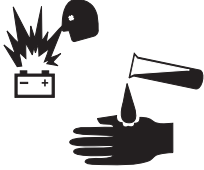

Safety Sign Maintenance

Replace any missing or damaged safety signs. Keep operator safety in mind at all times. Use mild soap and water to clean safety signs. Do not use solvent-based cleaners because they may damage the safety sign material.

Symbol and Hazard Pictorials Definitions

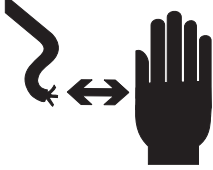
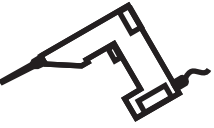
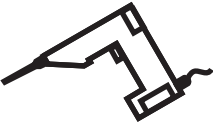
 <p>Crush hazard</p>	 <p>Keep away from moving parts</p>	 <p>Explosion hazard</p>	 <p>No smoking No flame Stop engine</p>	 <p>Electrocution hazard</p>
 <p>Maintain required clearance</p>	 <p>Crush hazard</p>	 <p>Keep away from path of moving platform</p>	 <p>Fall hazard</p>	 <p>Keep off this surface.</p>
 <p>Tip-over hazard</p>	 <p>Tip-over hazard</p>	 <p>Tip-over hazard</p>	 <p>Tip-over hazard</p>	 <p>Replace tires with tires of same specification.</p>
 <p>Lanyard anchorage points</p>	 <p>Read the operator's manual</p>	 <p>Only trained maintenance personnel should access compartments</p>	 <p>Wheel load</p>	 <p>Have fire extinguisher near.</p>

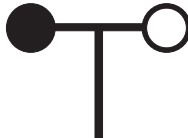
Symbol and Hazard Pictorials Definitions

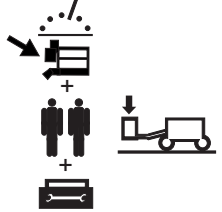
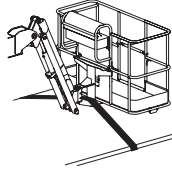
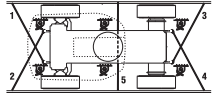
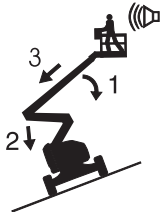
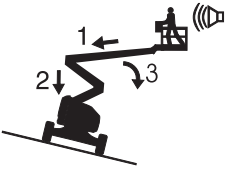
 <p>Explosion / Burn hazard</p>	 <p>Keep open flames away.</p>	 <p>Explosion hazard</p>	 <p>Do not use ether or other high energy starting aids on machines equipped with glow plugs.</p>	 <p>Read the service manual</p>
 <p>Electrocution hazard</p>	 <p>Avoid contact</p>	 <p>Voltage rating for power to platform</p>	 <p>Pressure rating for air line to platform</p>	 <p>Access by trained and authorized personnel only</p>
 <p>Maximum capacity</p>	 <p>Manual force</p>	 <p>Weight of welder reduces capacity</p>	 <p>Tie-down instructions</p>	 <p>Tie-down instructions</p>
<p>Recovery procedure if tilt alarm sounds while elevated.</p> <div style="display: flex; justify-content: space-around;"> <div data-bbox="227 1417 389 1627">  </div> <div data-bbox="446 1417 673 1585">  </div> </div> <div style="display: flex; justify-content: space-around; margin-top: 10px;"> <div data-bbox="186 1648 414 1774"> <p>Platform uphill:</p> <ol style="list-style-type: none"> 1 Lower primary. 2 Lower secondary. <p>Retract primary.</p> </div> <div data-bbox="438 1648 665 1774"> <p>Platform downhill:</p> <ol style="list-style-type: none"> 1 Retract primary. 2 Lower secondary. <p>Lower primary.</p> </div> </div>				

Personal Safety

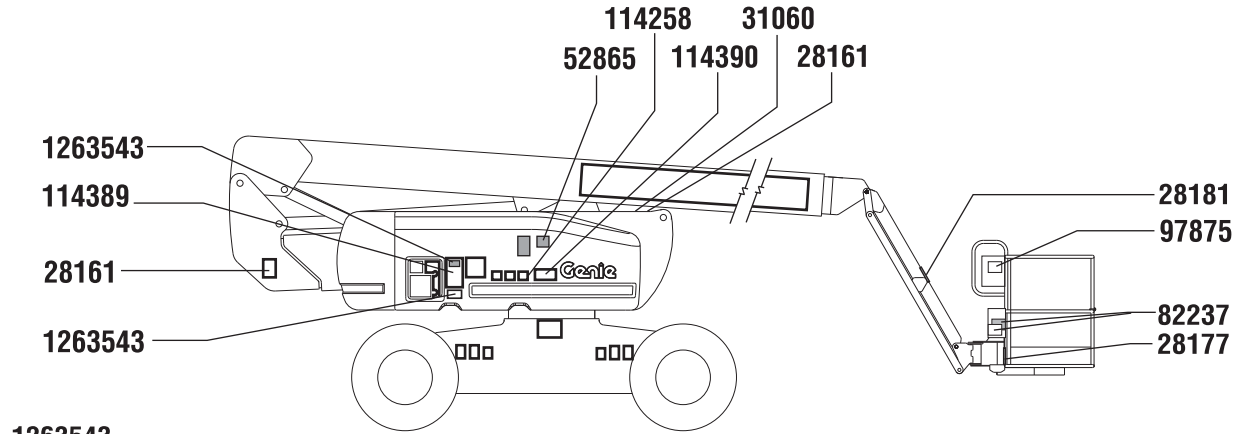

1263543

WARNING

Improper operation or maintenance of this equipment can result in death or serious injury.

Access by trained and authorized personnel only.

28161

WARNING

Crush Hazard
Contact with moving parts can result in death or serious injury.

Keep away from moving parts.

28181

WARNING

Fall Hazard
Death or serious injury may result from climbing or riding on boom.

Keep off this surface.

82237

DANGER

Electrocution Hazard
Contact with energized components can result in death or serious injury.

Avoid contact with energized components.

28177

WARNING

Crush Hazard
Death or serious injury may result from crushing personnel against boom.

Keep away from path of moving platform.

114389

DANGER

Failure to read, understand and obey the operator's manual and the following safety rules will result in death or serious injury.

Improper Use Hazard

The operator is responsible for safe machine operation. This includes:

- Avoid hazardous situations.
- Always perform a pre-operation inspection.
- Always perform function tests prior to use.
- Inspect work place.
- Only use the machine as it was intended.

Do not operate unless:

- You read, understand and obey:
 - manufacturer's instructions and safety rules— safety and operator manuals and decals
 - employer's safety rules
 - applicable governmental regulations
- You are properly trained to safely operate this machine.

Electrocution Hazards

This machine is not electrically insulated and will not provide protection from contact with or proximity to electrical current.

Line Voltage	Required Clearance
0 to 50KV	10 ft 3.0 m
50 to 100KV	15 ft 4.6 m
100 to 200KV	20 ft 6.1 m
200 to 300KV	25 ft 7.6 m
300 to 400KV	30 ft 9.1 m
400 to 500KV	35 ft 10.7 m

Tip-over Hazards

Do not raise or extend boom unless machine is on firm, level ground.

Do not depend on tilt alarm as a level indicator. Tilt alarm sounds in platform only when machine is on a severe slope.

Do not raise boom when wind speeds may exceed 28 mph / 12.6 m/s.

Do not operate machine in strong or gusty winds. Do not increase surface area of platform or load, increasing area exposed to wind will decrease machine stability.

Do not drive machine on or near uneven terrain, unstable surfaces or other hazardous conditions with boom raised or extended.

Do not drive machine on a slope that exceeds the maximum slope-side slope rating for the machine.

Use extreme care and slow speeds while driving the machine in steep position across uneven terrain, debris, unstable or slippery surfaces and near holes and deposits.

Do not attempt to free a caught or snagged platform using platform controls. All personnel must be removed from platform before attempting to free platform using ground controls.

Fall Hazards

Do not push off or pull toward any object outside of the platform.

Do not place or attach overhanging loads to any part of this machine.

Do not place ladders or scaffolds in platform or against any part of this machine.

Do not use machine on a moving or mobile surface or vehicle.

Be sure all pins are in good condition, anti-tilt pins are properly inflated and lug nuts are properly tightened.

Occupants must wear a safety belt or harness in accordance with governmental regulations. Attach lanyard to anchor provided in platform.

Do not sit, stand or climb on the platform guard rails.

Maintain a firm footing on the platform when raised.

Lower the platform entry rail or close the entry gate before operating.

Collision Hazards

Be aware of limited sight distance and blind spots when driving or operating.

Check work area for overhead obstructions or other possible hazards.

Be aware of crushing hazard when grasping the platform safety rail.

Observe and use color-coded direction arrows on the platform controls and drive chassis for drive and steer functions.

Explosion Hazard

Do not lower the boom unless the area below is clear of personnel and obstructions.

Do not start engine if you smell or detect liquid petroleum gas (LPG), gasoline, diesel fuel or other explosive substances.

Do not use the machine with the engine running.

Damaged Machine Hazards

Do not use a damaged or malfunctioning machine.

Be sure all maintenance has been performed as specified in the appropriate operator's and service manuals.

Be sure all decals are in place and legible.

Be sure safety, operator's and responsibilities manuals are complete, legible and in the storage container located on the platform.

114390

DANGER

Electrocution Hazard
Death or injury can result from contacting electric power lines.

Always contact the electric power line owner. The electric power shall be disconnected or the power lines moved or insulated before machine operations begin.

Line Voltage	Required Clearance
0 to 50KV	10 ft 3.0 m
50 to 100KV	15 ft 4.6 m
100 to 200KV	20 ft 6.1 m
200 to 300KV	25 ft 7.6 m
300 to 400KV	30 ft 9.1 m
400 to 500KV	35 ft 10.7 m

Maintain required clearance.

114258

DANGER

Burn Hazard
Fuel and fumes can explode and burn.

No smoking. No flame. Stop engine.

31060

DANGER

Tip-over Hazard
Altering or disabling limit switch can result in machine tip-over. Machine tip-over will result in death or serious injury.

Do not alter or disable limit switch(s).

52865

WARNING

Annual Inspection Record
Failure to complete required inspections could result in death or serious injury.

Scheduled maintenance inspections must be completed as specified in the appropriate service manual.

Use this decal to record the date of the annual inspection, the initial of the inspector and the machine number.

Use the maintenance inspection report in the service manual for recording. Keep records for four years.

Maintenance inspections must be completed in a pre-arranged and marked area reserved for this machine.

Date of Inspection	Inspected by	Serial Number

97875

WARNING

Electrocution Hazard
Failure to properly connect and use the weldline to platform could result in death or serious injury.

Read, understand and obey all warnings and instructions provided with welding power unit.

Turn welding power unit off before connecting leads.

Be sure weld cables are properly connected.

DC weld only. 40V, 300 amp maximum.

Component Damage Hazard
Failure to properly connect weld leads may result in machine or component damage.

Turn welding power unit off before connecting leads.

Connect leads to twist-lock connectors at turntable and platform.

Personal Safety

114389

⚠ DANGER

Failure to read, understand and obey the operator's manual and the following safety rules will result in death or serious injury.

Improper Use Hazard
The operator is responsible for safe machine operation. This includes:

1. Avoid hazardous situations.
2. Always perform a pre-operation inspection.
3. Always perform function tests prior to use.
4. Inspect work place.
5. Only use the machine as it was intended.

Do not operate unless:

- manufacturer's instructions and safety rules — safety and operator's manuals and decals
- employer's safety rules
- applicable governmental regulations

You are properly trained to safely operate this machine.

Electrocution Hazards
This machine is not electrically insulated and will not provide protection from contact with or proximity to electrical current.

Line Voltage	Required Clearance
0 to 200V	0 ft. 0.0 m
50 to 200V	15 ft. 4.6 m
50 to 250V	20 ft. 6.1 m
50 to 300V	25 ft. 7.6 m
50 to 350V	30 ft. 9.1 m
50 to 400V	35 ft. 10.7 m

Tip-over Hazards
Do not raise or extend boom unless machine is on firm, level ground.
Do not depend on tilt alarm as a level indicator. Tilt alarm sounds in platform only when machine is on a severe slope.
Do not raise boom when wind speeds may exceed 28 mph / 12.5 m/s.
Do not operate machine in strong or gusty winds. Do not increase surface area of platform or load, increasing area exposed to wind will decrease machine stability.
Do not drive machine on or near uneven terrain, unstable surfaces or other hazardous conditions with boom raised or extended.
Do not drive machine on a slope that exceeds the maximum slope or side slope rating for the machine.
Use extreme care and slow speeds while driving the machine in sloped position across uneven terrain, debris, unstable or slippery surfaces and near holes and openings.
Do not attempt to free a caught or snagged platform using platform controls. All personnel must be removed from platform before attempting to free platform using ground controls.

Do not alter or disable machine components that in any way affect safety and stability.
Do not push off or pull toward any object outside of the platform.
Do not place or attach overhanging loads to any part of this machine.
Do not place ladders or scaffolds in platform or against any part of this machine.
Do not use machine on a moving or mobile surface or vehicle.
Be sure all tires are in good condition, air-filled tires are properly inflated and lug nuts are properly tightened.

Fall Hazards
Occupants must wear a safety belt or harness in accordance with governmental regulations. Attach lanyard to anchor provided in platform.
Do not sit, stand or climb on the platform guard rails. Maintain a firm footing on the platform floor at all times.
Do not climb down from the platform when raised.
Lower the platform entry mid-rail and drive the entry gate before operating.

Collision Hazards
Be aware of limited sight distance and blind spots when driving or operating.
Check work area for overhead obstructions or other possible hazards.
Be aware of crushing hazard when grasping the platform guard rail.
Caution and use color-coded direction arrows on the platform controls and drive chassis for drive and steer functions.
Do not lower the boom unless the area below is clear of personnel and obstructions.

Explosion Hazard
Do not start engine if you smell or detect liquid petroleum gas (LPG), gasoline, diesel fuel or other explosive substances.
Do not refuel the machine with the engine running.

Damaged Machine Hazards
Do not use a damaged or malfunctioning machine. Be sure all maintenance has been performed as specified in the appropriate operator's and service manuals.
Be sure all decals are in place and legible.
Be sure safety, operator's and responsibilities manuals are complete, legible and in the storage container located on the platform.

82862 B

82862

⚠ DANGER

Fire Hazard
Serious injury or death will result if fire occurs while operating welder and fire extinguisher is not available.

Do not operate welder unless fire extinguisher is immediately available for instant use, per OSHA regulation 1926.352(d).

82862 B

97579

⚠ DANGER

Tip-over Hazard
Welder power supply reduces rated platform capacity and must be factored into total platform load.

Do not overload platform.
Welder power supply weighs 75 lbs / 34 kg.

97579 C

28236

⚠ WARNING

Read and understand Operator's Manual, Responsibilities Manual and Safety Manual and all safety signs before using or maintaining machine. If you do not understand the information in the manuals, consult your supervisor, the owner or the manufacturer.

28236 D

133236

⚠

STOP

• Stop all movement.

Tip-over Hazard
If tilt-alarm sounds, unit is on a severe slope. Death or serious injury will result.

• Read operator's manual before attempting to move machine.

Platform uphill:
1. Lower primary boom.
2. Retract/lower secondary boom.
3. Retract primary boom.

Platform downhill:
1. Retract primary boom.
2. Retract/lower secondary boom.
3. Lower primary boom.

133236 A

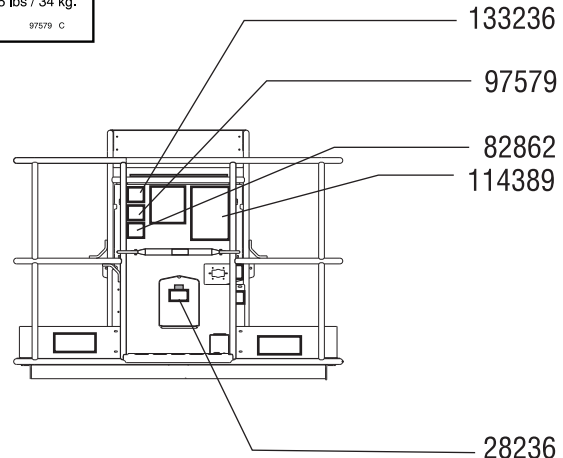

Personal Safety

28161

⚠ WARNING



Crush Hazard
Contact with moving parts can result in death or serious injury.



Keep away from moving parts.

28161 C

28177

⚠ WARNING



Crush Hazard
Death or serious injury may result from platform crushing personnel against boom.



Keep away from path of moving platform.

28177 C

31788

⚠ DANGER



Explosion / Burn Hazard
Ignition of explosive gases or contact with corrosive acid will cause death, burns or blindness.



Keep all open flames and sparks away. Wear personal protective equipment, including face shield, gloves and long sleeve shirt.

READ MANUALS
Read all manuals prior to operation.

DO NOT OPERATE equipment if you do not understand the information in the manuals. Consult your supervisor, the owner or the manufacturer.

31788 C

31060

⚠ DANGER

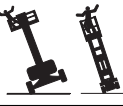

Tip-over Hazard
Altering or disabling limit switches can result in machine tip-over. Machine tip-over will result in death or serious injury.



Do not alter or disable limit switch(s).

31060 C

28175

⚠ WARNING



Compartment access is restricted. Contact with components under any cover may result in serious injury.



Only trained maintenance personnel should access compartments. Access by operator is only advised when performing Pre-operation Inspection. All compartments must remain closed and secured during operation.

28175 H

97875

⚠ WARNING

Electrocution Hazard
Failure to properly connect and use the weld line to platform could result in death or serious injury.

Component Damage Hazard
Failure to properly connect weld leads may result in machine or component damage.

Read, understand and obey all warnings and instructions provided with welding power unit. Turn welding power unit off before connecting leads. Be sure weld cables are properly connected. DC weld only; 40V, 300 amp maximum.

Turn welding power unit off before connecting leads. Connect leads to twist-lock connectors at turntable and platform.

97875 A

82237

⚠ DANGER



Electrocution Hazard
Contact with energized components can result in death or serious injury.



Avoid contact with energized components.

82237 B

97602

⚠ WARNING



Explosion Hazard
Death or serious injury can result from the use of ether or other high energy starting aids.



Do not use ether or other high energy starting aids on machines equipped with glow plugs.

97602 B

114390

⚠ DANGER



Electrocution Hazard
Death or injury can result from contacting electric power lines.

Always contact the electric power line owner. The electric power shall be disconnected or the power lines moved or insulated before machine operations begin.

114390 A

Maintain required clearance.		
Line Voltage	Required Clearance	
0 to 50KV	10 ft	3.0 m
50 to 200KV	15 ft	4.6 m
200 to 350KV	20 ft	6.1 m
350 to 500KV	25 ft	7.6 m
500 to 750KV	35 ft	10.6 m
750 to 1000KV	45 ft	13.7 m

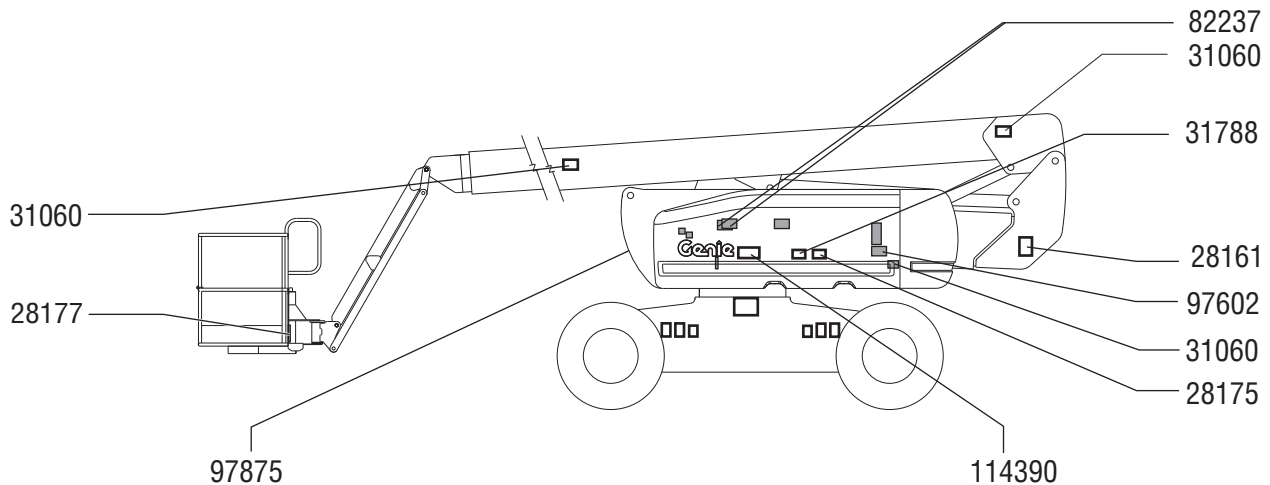

Personal Safety

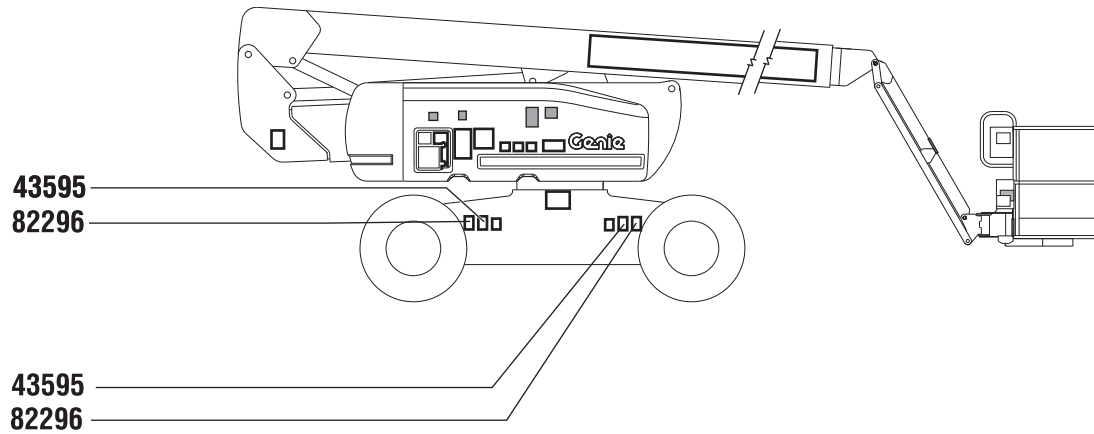

43595

⚠ DANGER	
	<p>Tip-over Hazard Do not use air-filled tires.</p>
	<p>This machine is equipped with foam-filled tires. Wheel weight and proper counterweight configuration are critical to stability.</p>
43595 B	

82296

⚠ DANGER	
	<p>Tip-over Hazard Failure to replace tires with tires of same specification will result in death or serious injury.</p>
	<p>Tires are critical to machine stability. Do not replace factory-installed tires with high flotation tires. Only replace factory-installed tires with tires of same specification and ply rating. Tire Size: 18-625, 16 Ply, Foam-filled</p>
<p>Lug Nut Torque Dry bolts: 420 ft-lbs / 569.5 Nm Lubricated bolts: 320 ft-lbs / 433.9 Nm Foam-Filled Tire, Minimum New Weight: 622 lbs / 282 kg</p>	
82296 D	

Personal Safety

Personal Fall Protection

Personal fall protection equipment (PFPE) is required when operating this machine.

Occupants must wear a safety belt or harness in accordance with governmental regulations. Attach the lanyard to the anchor provided in the platform.

Operators must comply with employer, job site and governmental rules regarding the use of personal protective equipment.

All PFPE must comply with applicable governmental regulations, and must be inspected and used in accordance with the PFPE manufacturer's instructions.

Work Area Safety

⚠ Electrocuting Hazards

This machine is not electrically insulated and will not provide protection from contact with or proximity to electrical current.



Obey all local and governmental regulations regarding required clearance from electrical power lines. At a minimum, the required clearance contained in the chart below must be followed.

Line Voltage	Required Clearance
0 to 50KV	3.05 m
50 to 200KV	4.60 m
200 to 350KV	6.10 m
350 to 500KV	7.62 m
500 to 750KV	10.67 m
750 to 1000KV	13.72 m

Allow for platform movement, electrical line sway or sag, and beware of strong or gusty winds.

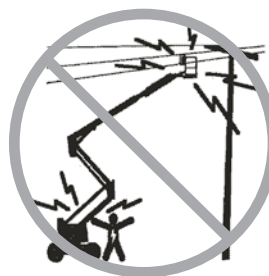

Keep away from the machine if it contacts energized power lines. Personnel on the ground or in the platform must not touch or operate the machine until energized power lines are shut off.

Do not operate the machine during lightning or storms.

Do not use the machine as a ground for welding.

⚠ Tip-over Hazards

Occupants, equipment and materials shall not exceed the maximum platform capacity or the maximum platform capacity of the platform extension.

Maximum platform capacity	227 kg
Maximum occupants	2

The weight of options and accessories, such as pipe cradles, panel cradles and welders, will reduce the rated platform capacity and must be subtracted from the platform capacity. See the decals with the options and accessories.

If using accessories, read, understand and obey the decals, instructions and manuals with the accessory.

Work Area Safety



Do not raise or extend the boom unless the machine is on a firm, level surface.



Do not depend on the tilt alarm as a level indicator. The tilt alarm sounds in the platform only when the machine is on a severe slope.

If the tilt alarm sounds while the boom is lowered: Do not extend, rotate or raise the boom above horizontal. Move the machine to a firm, level surface before raising the platform.

If the tilt alarm sounds when the platform is raised, use extreme caution. The Machine Not Level indicator light will come on and the drive function in one or both directions will not operate. Identify the condition of the boom on the slope as shown below. Follow the steps to lower the boom before moving to a firm, level surface. Do not rotate the boom while lowering.

The recovery mode should be used only by trained and authorized personnel.

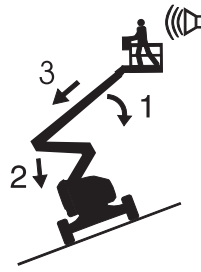

If the tilt alarm sounds with the platform uphill:

- 1 Lower the primary boom.
- 2 Retract/lower the secondary boom.
- 3 Retract the primary boom.

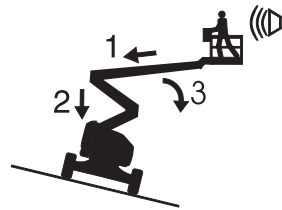

If the tilt alarm sounds with the platform downhill:

- 1 Retract the primary boom.
- 2 Retract/lower the secondary boom.
- 3 Lower the primary boom.

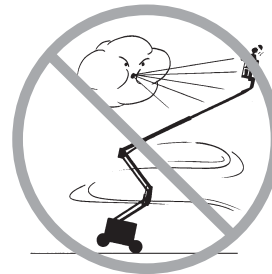

Do not raise the boom when wind speeds may exceed 12.5 m/s. If wind speeds exceed 12.5 m/s when the boom is raised, lower the boom and do not continue to operate the machine.

Do not operate the machine in strong or gusty winds. Do not increase the surface area of the platform or the load. Increasing the area exposed to the wind will decrease machine stability.

Work Area Safety



Use extreme care and slow speeds while driving the machine in the stowed position across uneven terrain, debris, unstable or slippery surfaces and near holes and drop-offs.

Do not drive the machine on or near uneven terrain, unstable surfaces or other hazardous conditions with the boom raised or extended.

Do not use the machine as a crane.

Do not push the machine or other objects with the boom.

Do not contact adjacent structures with the boom.

Do not tie the boom or platform to adjacent structures.

Do not place loads outside the platform perimeter.

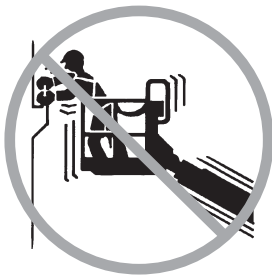

Do not push off or pull toward any object outside of the platform.

**Maximum allowable
manual force – 400 N**

Do not alter or disable machine components that in any way affect safety and stability.

Do not replace items critical to machine stability with items of different weight or specification.

Do not replace factory-installed tires with tires of different specification or ply rating.

Do not replace factory-installed foam-filled tires with air-filled tires. Wheel weight is critical to stability.

Do not modify or alter an aerial work platform without prior written permission from the manufacturer. Mounting attachments for holding tools or other materials onto the platform, toeboards or guard rail system can increase the weight in the platform and the surface area of the platform or the load.

Work Area Safety



Do not place or attach fixed or overhanging loads to any part of this machine.



Do not place ladders or scaffolds in the platform or against any part of this machine.

Do not transport tools and materials unless they are evenly distributed and can be safely handled by person(s) in the platform.

Do not use the machine on a moving or mobile surface or vehicle.

Be sure all tires are in good condition, air-filled tires are properly inflated and lug nuts are properly tightened.

Do not use the platform controls to free a platform that is caught, snagged or otherwise prevented from normal motion by an adjacent structure. All personnel must be removed from the platform before attempting to free the platform using the ground controls.

⚠ Operation on Slopes Hazards

Do not drive the machine on a slope that exceeds the maximum uphill, downhill or side slope rating of the machine. Slope rating applies only to machines in the stowed position.

Maximum slope rating, stowed position, 2WD

Platform downhill	30%	(17°)
Platform uphill	15%	(9°)
Side slope	25%	(14°)

Maximum slope rating, stowed position, 4WD

Platform downhill	45%	(24°)
Platform uphill	35%	(19°)
Side slope	25%	(14°)

Note: Slope rating is subject to ground conditions with one person in the platform and adequate traction. Additional platform weight may reduce slope rating. See Driving on a Slope in the Operating Instructions section.

Work Area Safety

⚠ Fall Hazards

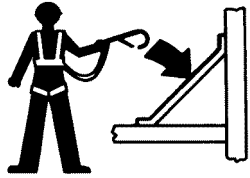

Occupants must wear a safety belt or harness in accordance with governmental regulations. Attach the lanyard to the anchor provided in the platform.



Do not sit, stand or climb on the platform guard rails. Maintain a firm footing on the platform floor at all times.



Do not climb down from the platform when raised.

Keep the platform floor clear of debris.

Lower the platform entry mid-rail or close the entry gate before operating.

Do not enter or exit the platform unless the machine is in the stowed position and the platform is at ground level.

⚠ Collision Hazards

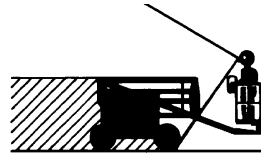

Be aware of limited sight distance and blind spots when driving or operating.

Be aware of the boom position and tailswing when rotating the turntable.



Check the work area for overhead obstructions or other possible hazards.



Be aware of crushing hazards when grasping the platform guard rail.

Operators must comply with employer, job site and governmental rules regarding use of personal protective equipment.

Work Area Safety

Observe and use the color-coded direction arrows on the platform controls and drive chassis for drive and steer functions.



Do not lower the boom unless the area below is clear of personnel and obstructions.



Limit travel speed according to the condition of the ground surface, congestion, slope, location of personnel, and any other factors which may cause collision.

Do not operate a boom in the path of any crane unless the controls of the crane have been locked out and/or precautions have been taken to prevent any potential collision.

No stunt driving or horseplay while operating a machine.

▲ Bodily Injury Hazard

Always operate the machine in a well-ventilated area to avoid carbon monoxide poisoning.

Do not operate the machine with a hydraulic oil or air leak. An air leak or hydraulic leak can penetrate and/or burn skin.

Improper contact with components under any cover will cause serious injury. Only trained maintenance personnel should access compartments. Access by the operator is only advised when performing a pre-operation inspection. All compartments must remain closed and secured during operation.

▲ Explosion and Fire Hazards

Do not start the engine if you smell or detect liquid petroleum gas (LPG), gasoline, diesel fuel or other explosive substances.

Do not refuel the machine with the engine running.

Refuel the machine and charge the battery only in an open, well-ventilated area away from sparks, flames and lighted tobacco.

Do not operate the machine or charge the battery in hazardous locations or locations where potentially flammable or explosive gases or particles may be present.

Do not spray ether into engines equipped with glow plugs.

Work Area Safety

⚠ Damaged Machine Hazards

Do not use a damaged or malfunctioning machine.

Conduct a thorough pre-operation inspection of the machine and test all functions before each work shift. Immediately tag and remove from service a damaged or malfunctioning machine.

Be sure all maintenance has been performed as specified in this manual and the appropriate Genie service manual.

Be sure all decals are in place and legible.

Be sure the operator's, safety and responsibilities manuals are complete, legible and in the storage container located on the machine.

⚠ Component Damage Hazards

Do not use any battery or charger greater than 12V to jump-start the engine.

Do not use the machine as a ground for welding.

Do not operate the machine in locations where extremely high magnetic fields may be present.

⚠ Battery Safety

Burn Hazards



Batteries contain acid. Always wear protective clothing and eye wear when working with batteries.

Avoid spilling or contacting battery acid. Neutralize battery acid spills with baking soda and water.

Explosion Hazards



Keep sparks, flames and lighted tobacco away from batteries. Batteries emit explosive gas.

⚠ Electrocutation Hazard

Avoid contact with electrical terminals.

Work Area Safety

▲ Pipe Cradle Safety

Read, understand and obey all warnings and instructions provided with the pipe cradles.

Do not exceed the rated platform capacity. The pipe cradle assembly and the weight in the pipe cradles will reduce rated platform capacity and must be factored into total platform load.

The pipe cradle assembly weighs 9.5 kg.

The maximum capacity of the pipe cradle assembly is 91 kg.

The weight of the pipe cradle assembly and the load in the pipe cradles may limit the maximum number of occupants in platform.

Center the load within the perimeter of the platform.

Secure the load to the platform.

Do not obstruct the entrance or the exit of the platform.

Do not obstruct the ability to operate the platform controls or the red Emergency Stop button.

Do not operate unless you are adequately instructed and are aware of all of the hazards associated with movement of the platform with an overhanging load.

Do not cause a horizontal force or side load to machine by raising or lowering a fixed or overhanging load.

Electrocution Hazard: Keep pipes away from all energized electrical conductors.

▲ Panel Cradle Safety

Read, understand and obey all warnings and instructions provided with the panel cradles.

Do not exceed the rated platform capacity. The combined weight of the cradles, panels, occupants, tools and any other equipment must not exceed rated capacity.

The panel cradle assembly weighs 13.6 kg.

The maximum capacity of the panel cradles is 113 kg.

The weight of the panel cradles and the load in the panel cradles may limit the maximum number of occupants in platform to one person.

Secure the cradles to the platform. Secure the panel(s) to the platform railing using the straps provided.

Do not operate unless you are adequately instructed and are aware of all hazards associated with lifting panels.

Do not cause a horizontal force or side load to machine by raising or lowering a fixed or overhanging load.

Maximum vertical height of panels: 1.2 m

Maximum wind speed: 6.7 m/sec

Maximum panel area: 3 m²

Work Area Safety

▲ Welder Safety

Read, understand and obey all warnings and instructions provided with the welding power unit.

Do not connect weld leads or cables unless the welding power unit is turned off at the platform controls.

Do not operate unless the weld cables are properly connected and the welder is properly grounded.

The weight of the welder will reduce the rated platform capacity and must be factored into the total platform load. The welder power supply weighs 34 kg.

Do not operate the welder unless a fire extinguisher is immediately available for instant use, per OSHA regulation 1926.352(d).

▲ Weld Line to Platform Safety

Read, understand and obey all warnings and instructions provided with the welding power unit.

Do not connect weld leads or cables unless the welding power unit is turned off at the platform controls.

Do not operate unless the weld cables are properly connected.

Connect the positive lead to the twist-lock connector at the turntable and platform.

Clamp the negative lead to the ground post at the turntable and platform.

Work Area Safety

Lockout After Each Use

- 1 Select a safe parking location—firm level surface, clear of obstruction and traffic.
- 2 Retract and lower the boom to the stowed position.
- 3 Rotate the turntable so that the boom is between the non-steer wheels.
- 4 Turn the key switch to the off position and remove the key to secure from unauthorized use.

Legend

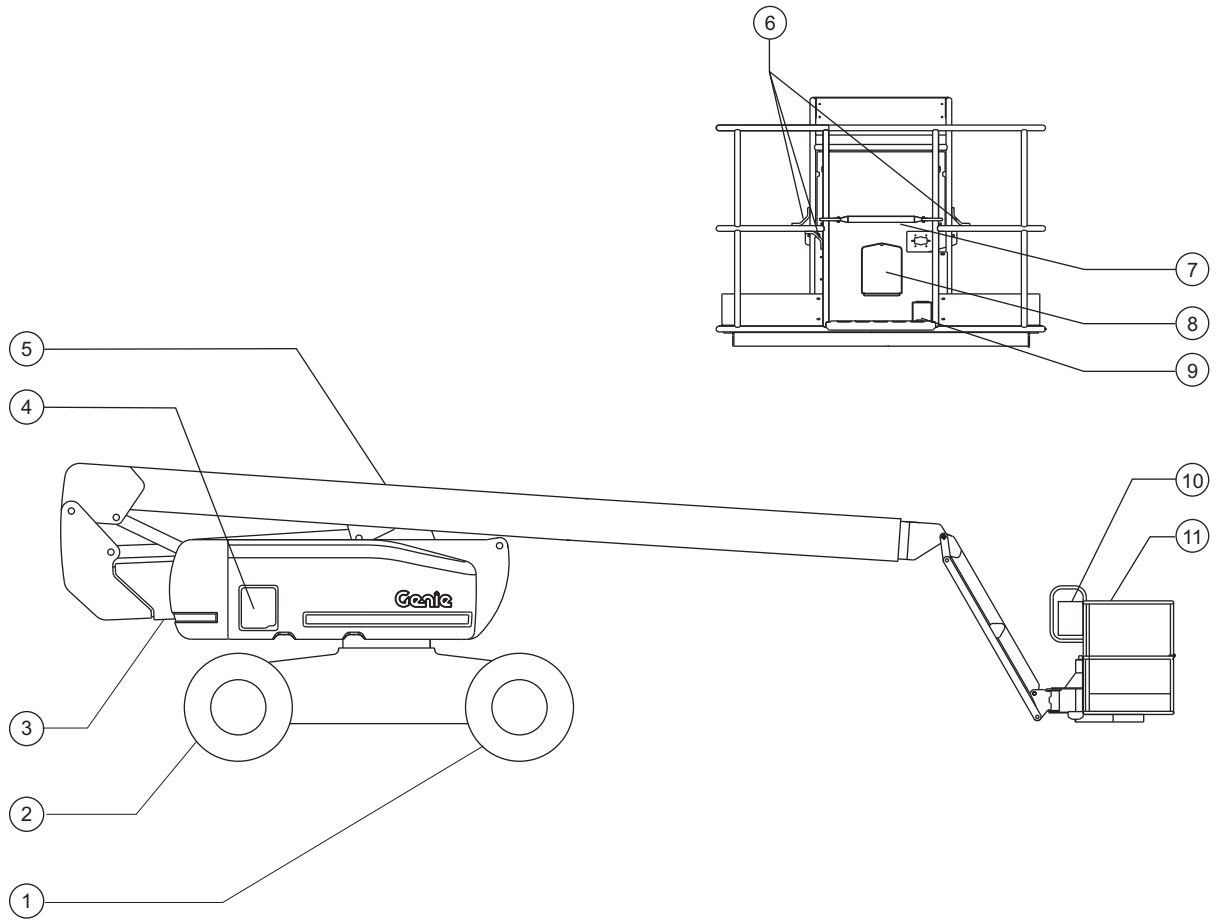

- 1 Circle-end tire
- 2 Square-end tire
- 3 Secondary boom
- 4 Ground controls
- 5 Primary boom

- 6 Lanyard anchorage points
- 7 Sliding mid-rail
- 8 Manual storage container
- 9 Foot switch
- 10 Platform controls
- 11 Platform

Controls

The Z-80 machines will have one of these two styles of ground control panel. The descriptions in this section and the instructions in the Function Test and Operating Instructions apply to both panels, unless specifically noted.

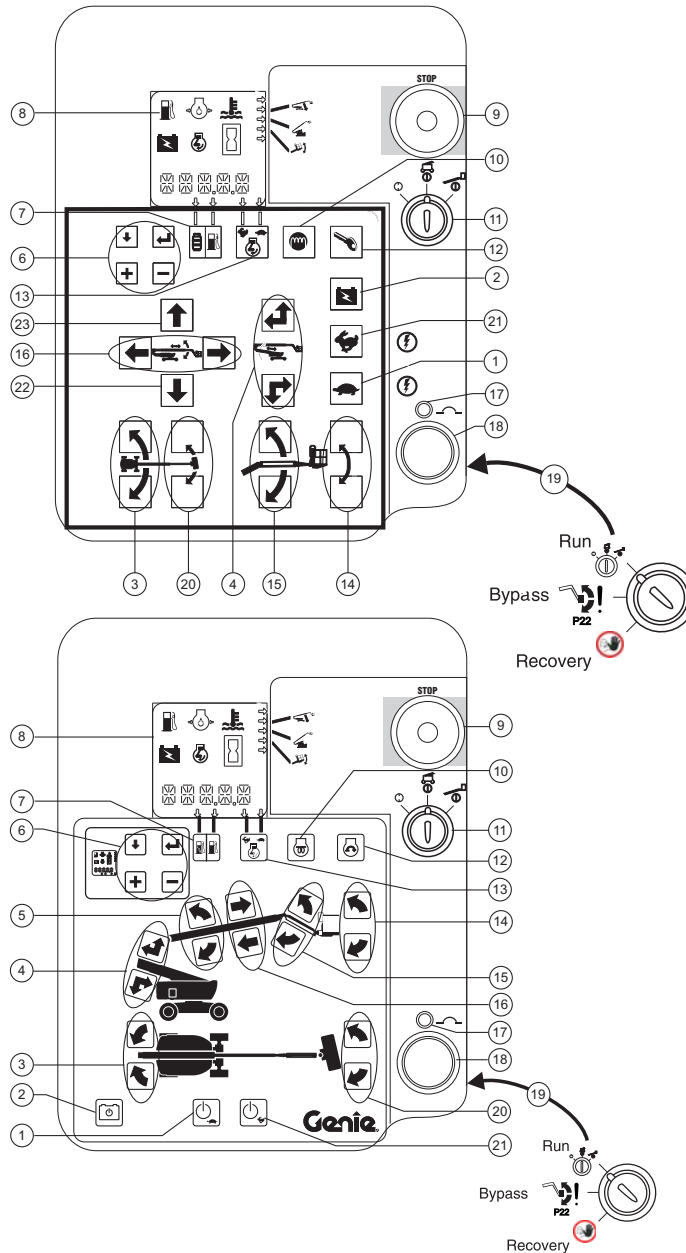

Controls

Ground Control Panel

1 Low speed function enable button

Press the low speed function enable button to enable the functions on the ground control panel to operate at low speed.

2 Emergency power button

Use emergency power if the primary power source (engine) fails. Simultaneously hold the emergency power button and activate the desired function.

3 Turntable rotate left/right buttons

Press the turntable rotate left button and the turntable will rotate to the left.

Press the turntable rotate right button and the turntable will rotate to the right.

4 Secondary boom up/extend and down/retract buttons

Push the secondary boom up/extend button and the secondary boom will raise and then extend. Push the secondary boom down/retract button and the secondary boom will retract and then lower.

5 Primary boom up/down buttons

Press the primary boom up button and the boom will raise. Press the primary boom down button and the boom will lower.

6 LCD screen control buttons

7 Gasoline/LPG models: fuel select button

Push the fuel select button to select the engine fuel source. When the arrow above the LPG tank is lit, the engine will run on LPG. When the arrow above the gas tank is lit, the engine will run on gasoline.

8 LCD readout screen



a low fuel indicator

b engine oil pressure indicator

c water temperature indicator

d emergency power indicator

e engine rpm indicator

f hour meter

9 Red Emergency Stop button

Push in the red Emergency Stop button to the off position to stop all functions and turn the engine off. Pull out the red Emergency Stop button to the on position to operate the machine.

10 Glow plug button (if equipped with manual glow plugs)

Controls

- 11 Key switch for off/ground/platform selection
Turn the key switch to the off position and the machine will be off. Turn the key switch to the ground position and the ground controls will operate. Turn the key switch to the platform position and the platform controls will operate.
- 12 Engine start button
Push the engine start button and the engine will start.
- 13 Engine speed select button
Press the engine speed select button to select the engine speed. When the arrow above the rabbit is lit, the engine is in high idle speed. When the arrow above the turtle is lit, the engine is in low idle speed.
- 14 Platform level up/down buttons
Press the platform level up button and the level of the platform will raise. Press the platform level down button and the level of the platform will lower.
- 15 Jib boom up/down buttons
Press the jib boom up button and the jib boom will raise. Press the jib boom down button and the jib boom will lower.
- 16 Primary boom extend/retract buttons
Press the primary boom extend button and the primary boom will extend. Press the primary boom retract button and the primary boom will retract.
- 17 20A circuit breaker for system circuit
- 18 Alarm
- 19 Bypass/recovery key switch
Bypass key position to be used only to level the platform if the ground control display shows platform out of level (P22) and platform level controls do not work. Refer to the operating instructions.
Recovery key position should be used only by trained and authorized personnel.
- 20 Platform rotate left/right buttons
Press the platform rotate left button and the platform will rotate left.
Press the platform rotate right button and the platform will rotate right.
- 21 High speed function enable button
Press the high speed function enable button to enable the functions on the ground control panel to operate at high speed.
- 22 Primary boom down button
Press the primary boom down button and the boom will lower.
- 23 Primary boom up button
Press the primary boom up button and the boom will raise.

Controls

The Z-80 machines will have one of these two styles of platform control panel. The descriptions in this section and the instructions in the Function Test and Operating Instructions apply to both panels, unless specifically noted.

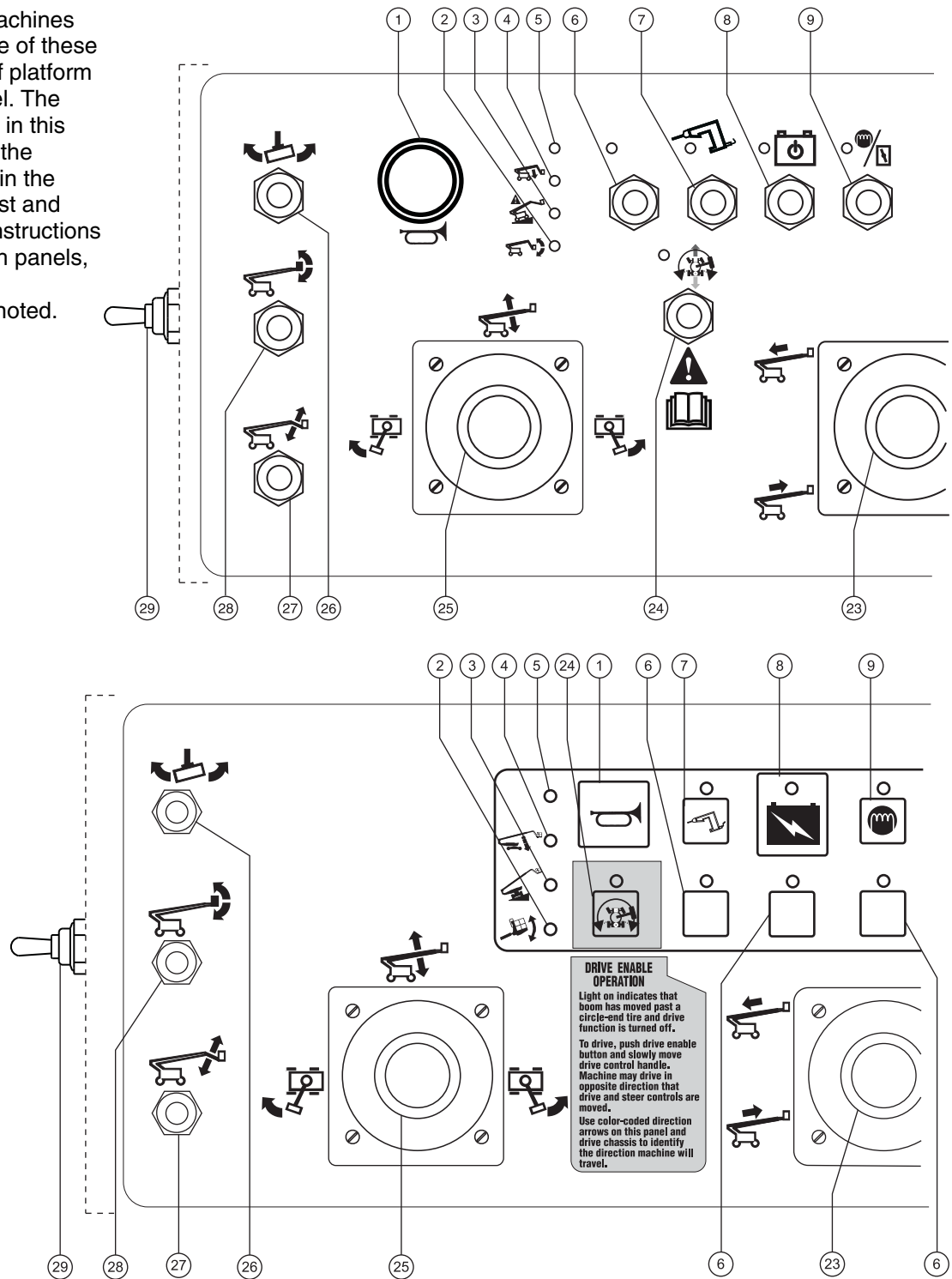

Controls

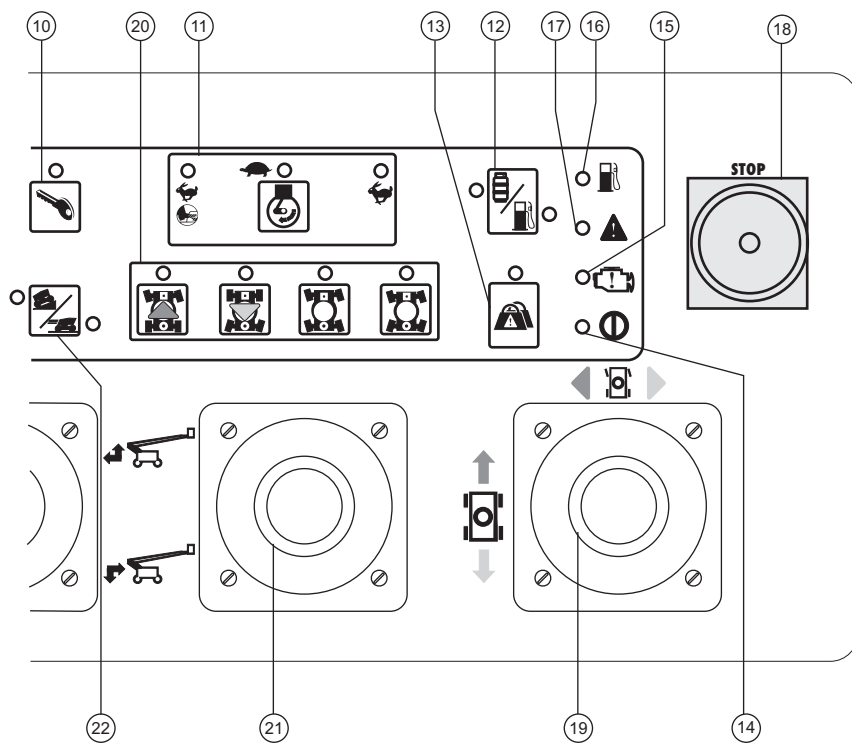
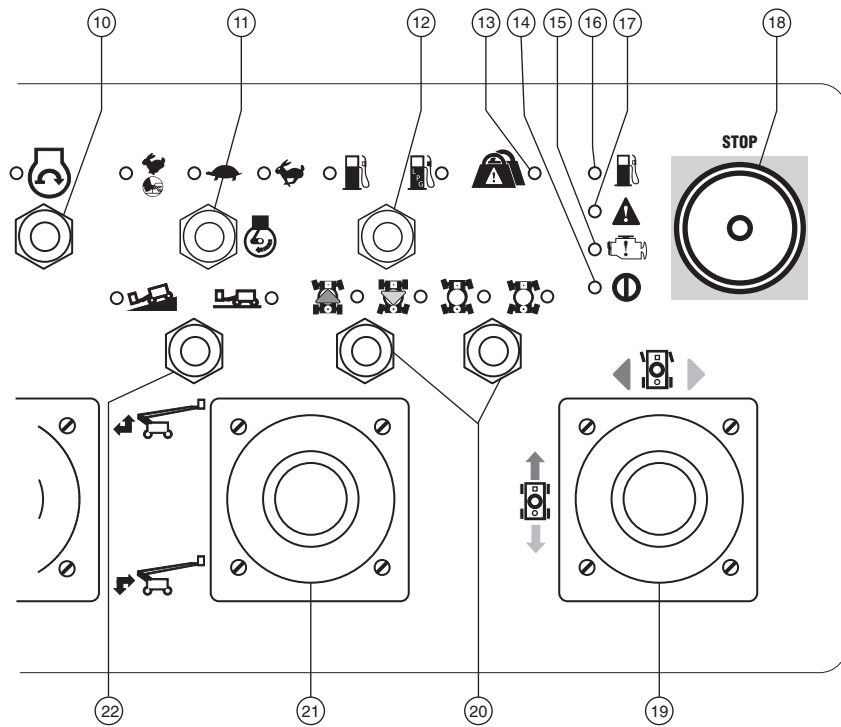

Controls

Platform Control Panel

- 1 Horn button
Press this button and the horn will sound. Release the button and the horn will stop.
- 2 Platform not level indicator light
Level the platform until the light is off. The platform level toggle switch will only work in the direction that will level the platform.
- 3 Machine not level indicator light
Light is on when the platform is raised and the machine is on a severe slope. The drive function in one or both directions will not operate.
- 4 Lower primary boom indicator light
Lower the primary boom until the light is off.
- 5 Not used
- 6 Used for optional equipment
- 7 Generator control with indicator light (if equipped)
Move the switch or press the button to turn the generator on. Move the switch again or release the button to turn the generator off.
- 8 Emergency/Auxiliary power control with indicator light
Use emergency/auxiliary power if the primary power source (engine) fails. Move and hold the switch or press and hold the button. Activate the desired function. The indicator light will be on when emergency/auxiliary power is being used.
- 9 Diesel models:Glow plug control with indicator light
Move the switch or push the button to activate the glow plugs.
Diesel models:Automatic glow plug indicator light
Amber light indicates glow plugs are on.
Gasoline/LPG models:Choke switch with indicator light (if equipped)
Move the switch to activate the choke.
- 10 Engine start control with indicator light
Move the switch or push the button to start the engine. The indicator light will be on when the switch is moved or the button is pushed.
- 11 Engine idle control with indicator light
Move the switch or push the button to select the engine idle setting. The indicator light next to the current engine idle setting will be on.

Controls

- 12 Gasoline/LPG models:Fuel select control with indicator light
Move the switch or push the button to select the fuel source. The indicator light next to the current fuel selection will be on.
- 13 Platform overload indicator light
Light flashing indicates the platform is overloaded. The engine will stop and no functions will operate. Remove weight until the light goes off and then restart the engine.
- 14 Power indicator light
Light on indicates the machine is on.
- 15 Check engine indicator light
Light on indicates an engine fault.
- 16 Low fuel indicator light
Light on indicates the machine is low on fuel.
- 17 Fault indicator light
Light on indicates a system fault.
- 18 Red Emergency Stop button
Push in the red Emergency Stop button to the off position to stop all functions and turn the engine off. Pull out the red Emergency Stop button to the on position to operate the machine.
- 19 Dual axis proportional control handle for drive and steer functions
OR Proportional control handle for drive function and thumb rocker for steer function.
Move the control handle in the direction indicated by the blue arrow on the control panel and the machine will drive forward. Move the control handle in the direction indicated by the yellow arrow and the machine will drive backwards. Move the control handle in the direction indicated by the blue triangle and the machine will steer to the left. Move the control handle in the direction indicated by the yellow triangle and the machine will steer to the right.
OR
Move the control handle in the direction indicated by the blue arrow on the control panel and the machine will drive forward. Move the control handle in the direction indicated by the yellow arrow and the machine will drive backwards. Press the left side of the thumb rocker and the machine will steer to the left. Press the right side of the thumb rocker and the machine will steer to the right.
- 20 Steer mode control with indicator lights
Move the switch or push the button to choose steer mode. The indicator light next to the current steer mode will be on.

Controls

- 21 Single axis proportional control handle for secondary boom up/extend and down/retract function

Move the control handle up and the secondary boom will raise and then extend. Move the control handle down and the secondary boom will retract and then lower.

- 22 Drive control with indicator lights

Move the switch or push the button to choose the drive setting. The indicator light next to the current setting will be on.

- 23 Single axis proportional control handle for primary boom extend/retract function

Move the control handle down and the boom will extend. Move the control handle up and the boom will retract.

- 24 Drive enable control with indicator light

Light on indicates that the primary boom has moved past either circle-end wheel and the drive function is turned off. To drive, move the drive enable switch or push the drive enable button and slowly move the drive control handle off center.

- 25 Dual axis proportional control handle for primary boom up/down and turntable rotate left/right functions

Move the control handle up and the primary boom will raise. Move the control handle down and the primary boom will lower.

Move the control handle to the right and the turntable will rotate to the right. Move the control handle to the left and the turntable will rotate to the left.

- 26 Platform rotate switch

Move the platform rotate switch to the right and the platform will rotate to the right. Move the platform rotate switch to the left and the platform will rotate to the left.

- 27 Platform level switch

Move the platform level switch up and the level of the platform will raise. Move the platform level switch down and the level of the platform will lower.

- 28 Jib boom up/down switch

Move the jib boom switch up and the jib boom will raise. Move the jib boom switch down and the jib boom will lower.

- 29 Platform level recovery switch
(located on the side of the platform controls)

Push and hold the platform level recovery switch up. Use the platform level switch to level the platform.

Inspections



Do Not Operate Unless:

- You learn and practice the principles of safe machine operation contained in this operator's manual.
 - 1 Avoid hazardous situations.
 - 2 Always perform a pre-operation inspection.**
- Know and understand the pre-operation inspection before going on to the next section.**
- 3 Always perform function tests prior to use.
- 4 Inspect the workplace.
- 5 Only use the machine as it was intended.

Pre-operation Inspection Fundamentals

It is the responsibility of the operator to perform a pre-operation inspection and routine maintenance.

The pre-operation inspection is a visual inspection performed by the operator prior to each work shift. The inspection is designed to discover if anything is apparently wrong with a machine before the operator performs the function tests.

The pre-operation inspection also serves to determine if routine maintenance procedures are required. Only routine maintenance items specified in this manual may be performed by the operator.

Refer to the list on the next page and check each of the items.

If damage or any unauthorized variation from factory delivered condition is discovered, the machine must be tagged and removed from service.

Repairs to the machine may only be made by a qualified service technician, according to the manufacturer's specifications. After repairs are completed, the operator must perform a pre-operation inspection again before going on to the function tests.

Scheduled maintenance inspections shall be performed by qualified service technicians, according to the manufacturer's specifications and the requirements listed in the responsibilities manual.

Inspections

Pre-operation Inspection

- Be sure that the operator's, safety and responsibilities manuals are complete, legible and in the storage container located in the platform.
- Be sure that all decals are legible and in place. See Inspections section.
- Check for hydraulic oil leaks and proper oil level. Add oil if needed. See Maintenance section.
- Check for battery fluid leaks and proper fluid level. Add distilled water if needed. See Maintenance section.
- Check for engine oil leaks and proper oil level. Add oil if needed. See Maintenance section.
- Check for engine coolant leaks and proper level of coolant. Add coolant if needed. See Maintenance section.
- Check air-filled tires for proper tire pressure. Add air if needed. See Maintenance section.

Check the following components or areas for damage, improperly installed or missing parts and unauthorized modifications:

- Electrical components, wiring and electrical cables
- Hydraulic hoses, fittings, cylinders and manifolds
- Fuel and hydraulic tanks
- Drive and turntable motors and drive hubs

- Wear pads
- Tires and wheels
- Engine and related components
- Limit switches and horn
- Alarms and beacons (if equipped)
- Nuts, bolts and other fasteners
- Platform entry mid-rail or gate

Check entire machine for:

- Cracks in welds or structural components
- Dents or damage to machine
- Excessive rust, corrosion or oxidation
- Be sure that all structural and other critical components are present and all associated fasteners and pins are in place and properly tightened.
- After you complete your inspection, be sure that all compartment covers are in place and latched.

Inspections



Do Not Operate Unless:

- ☑ You learn and practice the principles of safe machine operation contained in this operator's manual.
 - 1 Avoid hazardous situations.
 - 2 Always perform a pre-operation inspection.
 - 3 Always perform function tests prior to use.**

Know and understand the function tests before going on to the next section.

- 4 Inspect the workplace.
- 5 Only use the machine as it was intended.

Function Test Fundamentals

The function tests are designed to discover any malfunctions before the machine is put into service. The operator must follow the step-by-step instructions to test all machine functions.

A malfunctioning machine must never be used. If malfunctions are discovered, the machine must be tagged and removed from service. Repairs to the machine may only be made by a qualified service technician, according to the manufacturer's specifications.

After repairs are completed, the operator must perform a pre-operation inspection and function tests again before putting the machine into service.

Inspections

At the Ground Controls

- 1 Select a test area that is firm, level and free of obstruction.
- 2 Turn the key switch to ground control.
- 3 Pull out the red Emergency Stop button to the on position.
- ⊙ Result: The LCD screen will come on and display no error messages. The beacon (if equipped) should flash.

Note: In cold climates, the LCD readout screen will need to warm up before the display appears.





- 4 Start the engine. See Operating Instructions section.

Test Emergency Stop

- 5 Push in the red Emergency Stop button to the off position.
- ⊙ Result: The engine should shut off and no functions should operate.
- 6 Pull out the red Emergency Stop button to the on position and restart the engine.

Test Machine Functions

- 7 Do not press and hold a function enable/speed select button. Attempt to activate each boom and platform function button.





- ⊙ Result: No boom and platform functions should operate.
- 8 Press and hold a function enable/speed select button and activate each boom and platform function button.
- ⊙ Result: All boom and platform functions should operate through a full cycle. The descent alarm should sound while the boom is lowering.

Test Emergency Controls

- 9 Turn the key switch to ground control and shut the engine off.
- 10 Pull out the red Emergency Stop button to the on position.
- 11 Simultaneously hold the emergency power switch on and activate each boom function toggle switch.



OR





Note: To conserve battery power, test each function through a partial cycle.

- ⊙ Result: All boom functions should operate.







Test the Tilt Sensor

- 12 Press one of the LCD screen control buttons until TURNTABLE LEVEL SENSOR X-DIRECTION appears.



- ⊙ Result: The LCD screen should display the angle in degrees.
- 13 Press the LCD screen control buttons until TURNTABLE LEVEL SENSOR Y-DIRECTION appears.
- ⊙ Result: The LCD screen should display the angle in degrees.
- 14 Press the LCD screen control buttons until PLATFORM LEVEL SENSOR DEGREES appears.
- ⊙ Result: The LCD screen should display the angle in degrees.

Inspections

Test the Operating Envelope

- 15 Press the LCD screen control buttons shown until PRI BOOM ANGLE TO GRAVITY is displayed.  
- 16 Raise the primary boom and observe the LCD screen.
- ⊙ Result: The primary boom should raise and the LCD screen should display the primary boom angle in degrees from 35 to 65. The primary boom should stop when the screen reads 65 degrees.
- 17 Lower the primary boom.
- 18 Simultaneously press the 2 LCD screen control buttons shown to activate status mode.  
- 19 Press the LCD screen control buttons shown until SEC BOOM ANGLE is displayed.  
- 20 Press and hold the secondary boom up/extend button.
- ⊙ Result: The secondary boom should raise and the LCD screen should display:
 - =0
 - >0
 - >35
 - =65
 The secondary boom should raise and then extend. The secondary boom should not extend until it is fully raised.
- 21 Press and hold the secondary boom down/retract button.
- ⊙ Result: The secondary boom should fully retract and then lower. The secondary boom should not lower unless it is fully retracted.

At the Platform Controls

Test Emergency Stop

- 22 Turn the key switch to platform control.
- 23 Push in the platform red Emergency Stop button to the off position.
- ⊙ Result: The engine should shut off and no functions should operate.
- 24 Pull out the red Emergency Stop button and restart the engine.

Test the Hydraulic Return Filter

- 25 Press the engine idle speed select button or move the switch until the indicator light next to the high idle (rabbit symbol) is on.
- 26 Locate and check the hydraulic filter condition indicator.
- ⊙ Result: The filter should be operating with the plunger or the needle in the green area.
- 27 Press the engine idle speed select button or move the switch until the indicator light next to the foot switch activated high idle (rabbit and foot switch symbol) is on.

Test the Horn

- 28 Press the horn button.
- ⊙ Result: The horn should sound.

Inspections

Test the Tilt Sensor Alarm

- 29 Push a button or move a switch, such as the engine idle select.
- ⊙ Result: The alarm should sound at the platform controls.



Test the Foot Switch

- 30 Push in the platform red Emergency Stop button to the off position.
- 31 Pull out the red Emergency Stop button to the on position and do not start the engine.
- 32 Press down the foot switch and attempt to start the engine.
- ⊙ Result: The engine should not start.
- 33 Do not press down the foot switch and restart the engine.
- ⊙ Result: The engine should start.
- 34 Do not press down the foot switch and test each machine function.
- ⊙ Result: No functions should operate.



Test Machine Functions

- 35 Press down the foot switch.
- 36 Activate each machine function control handle, toggle switch or button.
- ⊙ Result: All functions should operate through a full cycle.

Test the Steering (models with 4 wheel steer)

- 37 Select square-end (blue arrow) steer. Push the square-end (blue arrow) steer button or move the steer mode switch. 
- 38 Press down the foot switch.
- 39 Slowly move the drive control handle in the direction indicated by the blue triangle on the control panel OR press the thumb rocker switch in the direction indicated by the blue triangle.
- ⊙ Result: The square-end wheels should turn in the direction that the blue triangles point on the drive chassis.
- 40 Slowly move the control handle in the direction indicated by the yellow triangle on the control panel OR press the thumb rocker switch in the direction indicated by the yellow triangle.
- ⊙ Result: The square-end wheels should turn in the direction that the yellow triangles point on the drive chassis.
- 41 Select circle-end (yellow arrow) steer. Push the circle-end (yellow arrow) steer button or move the steer select switch. 
- 42 Press down the foot switch.

Inspections

- 43 Slowly move the control handle in the direction indicated by the yellow triangle on the control panel OR press the thumb rocker switch in the direction indicated by the yellow triangle.
- ⊙ Result: The circle-end wheels should turn in the direction that the blue triangles point on the drive chassis.
- 44 Slowly move the drive control handle in the direction indicated by the blue triangle on the control panel OR press the thumb rocker switch in the direction indicated by the blue triangle.
- ⊙ Result: The circle-end wheels should turn in the direction that the yellow triangles point on the drive chassis.
- 45 Select crab steer. Push the crab steer button or move the steer mode switch.
- 
- 46 Press down the foot switch.
- 47 Slowly move the drive control handle in the direction indicated by the blue triangle on the control panel OR press the thumb rocker switch in the direction indicated by the blue triangle.
- ⊙ Result: All wheels should turn in the direction that the blue triangles point on the drive chassis.
- 48 Slowly move the control handle in the direction indicated by the yellow triangle on the control panel OR press the thumb rocker switch in the direction indicated by the yellow triangle.
- ⊙ Result: All wheels should turn in the direction that the yellow triangles point on the drive chassis.
- 49 Select coordinated steer. Push the coordinated steer button or move the steer mode switch.
- 
- 50 Press down the foot switch.
- 51 Slowly move the drive control handle in the direction indicated by the blue triangle on the control panel OR press the thumb rocker switch in the direction indicated by the blue triangle.
- ⊙ Result: The square-end wheels should turn in the direction that the blue triangles point on the drive chassis. The circle-end wheels should turn in the direction that the yellow triangles point on the drive chassis.
- 52 Slowly move the control handle in the direction indicated by the yellow triangle on the control panel OR press the thumb rocker switch in the direction indicated by the yellow triangle.
- ⊙ Result: The square-end wheels should turn in the direction that the blue triangles point on the drive chassis. The circle-end wheels should turn in the direction that the yellow triangles point on the drive chassis.

Inspections

Test the Steering (models with 2 wheel steer)

- 53 Press down the foot switch.
- 54 Press the thumb rocker switch on top of the drive control handle in the direction indicated by the blue triangle on the control panel OR slowly move the control handle in the direction indicated by the blue triangle.
- ⊙ Result: The steer wheels should turn in the direction that the blue triangles point on the drive chassis.
- 55 Press the thumb rocker switch in the direction indicated by the yellow triangle on the control panel OR slowly move the control handle in the direction indicated by the yellow triangle.
- ⊙ Result: The steer wheels should turn in the direction that the yellow triangles point on the drive chassis.

Test Drive and Braking

- 56 Press down the foot switch.
- 57 Slowly move the drive control handle in the direction indicated by the blue arrow on the control panel until the machine begins to move, then return the handle to the center position.
- ⊙ Result: The machine should move in the direction that the blue arrow points on the drive chassis, then come to an abrupt stop.
- 58 Slowly move the control handle in the direction indicated by the yellow arrow on the control panel until the machine begins to move, then return the handle to the center position.
- ⊙ Result: The machine should move in the direction that the yellow arrow points on the drive chassis, then come to an abrupt stop.

Note: The brakes must be able to hold the machine on any slope it is able to climb.

Test the Oscillating Axle (if equipped)

- 59 Start the engine from the platform controls.
- 60 Drive the right square-end tire up onto a 15 cm block or curb.
- ⊙ Result: The three remaining tires should stay in firm contact with the ground.
- 61 Drive the left square-end tire up onto a 15 cm block or curb.
- ⊙ Result: The three remaining tires should stay in firm contact with the ground.
- 62 Drive both square-end tires up onto a 15 cm block or curb.
- ⊙ Result: The circle-end tires should stay in firm contact with the ground.

Inspections

Test the Drive Enable System

- 63 Press down the foot switch and lower the boom to the stowed position.
- 64 Rotate the turntable until the primary boom moves past one of the circle-end tires.

- ⊙ Result: The drive enable indicator light should come on and remain on while the boom is anywhere in the range shown.



- 65 Move the drive control handle off center.
- ⊙ Result: The drive function should not operate.
- 66 Push the drive enable button or move the switch and slowly move the drive control handle off center.
- ⊙ Result: The drive function should operate.

Note: When the drive enable system is in use, the machine may drive in the opposite direction that the drive and steer control handle is moved.

Use the color-coded direction arrows on the platform controls and the drive chassis to identify the direction of travel.

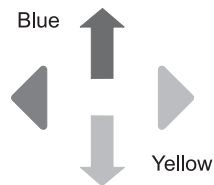

If the drive control handle is not moved within two seconds of moving the drive enable toggle switch, the drive function will not operate.

Test Limited Drive Speed

- 67 Press down the foot switch.
- 68 Raise the primary boom to 10° above horizontal.
- 69 Slowly move the drive control handle to the full drive position.
- ⊙ Result: The maximum achievable drive speed with the primary boom raised should not exceed 30 cm/s.

Note: Models with foam-filled tires will travel 12 m in 40 seconds. Models with high-flotation tires will travel 12 m in 62seconds.

- 70 Lower the primary boom to the stowed position.
- 71 Extend the boom 1.2 m.
- 72 Slowly move the drive control handle to the full drive position.
- ⊙ Result: The maximum achievable drive speed with the primary boom extended should not exceed 30 cm/s.

Note: The machine will travel 12 m in 40 seconds.

- 73 Retract the primary boom to the stowed position.
- 74 Raise the secondary boom to 10° above horizontal.
- 75 Slowly move the drive control handle to the full drive position.
- ⊙ Result: The maximum achievable drive speed with the secondary boom raised should not exceed 30 cm/s.

Note: Models with foam-filled tires will travel 12 m in 40 seconds. Models with high-flotation tires will travel 12 m in 62seconds.

- 76 Lower the secondary boom to the stowed position.

If the drive speed with the primary or secondary boom raised or the primary boom extended exceeds 30 cm per second, immediately tag and remove the machine from service.

Inspections

Test the Platform Level Recovery

- 77 Press down the foot switch.
- 78 Push and hold the platform level recovery switch up.
- 79 Move the platform level switch up and the level of the platform will raise.
 - ⊙ Result: The platform should return to a level position.
- 80 Move the platform level switch down and the level of the platform will lower.
 - ⊙ Result: The platform should return to a level position.
- 81 Note: The platform level switch will only work in the direction that will return the platform to a level position.

Test Emergency Controls

- 82 Push in the red Emergency Stop button to the off position to shut off the engine.
- 83 Pull out the red Emergency Stop button to the on position.
- 84 Press down the foot switch.
- 85 Activate the emergency controls. Move and hold the switch or push and hold the button. Activate each function control handle, toggle switch or thumb rocker switch.

Note: To conserve battery power, test each function through a partial cycle.

- ⊙ Result: All boom and steer functions should operate.

Test Aircraft Protection Package (if equipped)

Note: Two people may be required to perform this test.

- 86 Move the yellow bumper at the bottom of the platform 10 cm in any direction.
- 87 Activate each function control handle or toggle switch.
 - ⊙ Result: No boom and steer functions should operate.
- 88 Activate the function override. Move and hold the switch or push and hold the button.
- 89 Activate each function control handle or toggle switch.
 - ⊙ Result: All boom and steer functions should operate.

Test the Lift/Drive Select Function

- 90 Press down the foot switch.
- 91 Move the drive control handle off center and activate a boom function. Push a boom function button or move a boom function switch.
 - ⊙ Result: No boom functions should operate. The machine will move in the direction indicated on the control panel.

Inspections



Do Not Operate Unless:

- You learn and practice the principles of safe machine operation contained in this operator's manual.
 - 1 Avoid hazardous situations.
 - 2 Always perform a pre-operation inspection.
 - 3 Always perform function tests prior to use.
 - 4 Inspect the workplace.**

Know and understand the workplace inspection before going on to the next section.

 - 5 Only use the machine as it was intended.

Workplace Inspection Fundamentals

The workplace inspection helps the operator determine if the workplace is suitable for safe machine operation. It should be performed by the operator prior to moving the machine to the workplace.

It is the operator's responsibility to read and remember the workplace hazards, then watch for and avoid them while moving, setting up and operating the machine.

Workplace Inspection Checklist

Be aware of and avoid the following hazardous situations:

- drop-offs or holes
- bumps, floor obstructions or debris
- sloped surfaces
- unstable or slippery surfaces
- overhead obstructions and high voltage conductors
- hazardous locations
- inadequate surface support to withstand all load forces imposed by the machine
- wind and weather conditions
- the presence of unauthorized personnel
- other possible unsafe conditions

Inspections

Inspection for Decals with Words

Use the pictures on the next page to verify that all decals are legible and in place.

Below is a numerical list with quantities and descriptions.

Part No.	Decal Description	Qty
25994	Notice – Component Damage Hazard	1
27204	Arrow – Blue	1
27205	Arrow – Yellow	1
27206	Triangle – Blue	2
27207	Triangle – Yellow	2
28158	Label – Unleaded	1
28159	Label – Diesel	1
28160	Label – Liquid Petroleum Gas	1
28161	Warning – Crushing Hazard	3
28165	Instructions – Foot Switch	1
28174	Label – Power to Platform, 230V	3
28175	Warning – Compartment Access	1
28176	Label – Missing Manuals	1
28177	Warning – Collision Hazard	2
28181	Warning – No Step or Ride	1
28235	Label – Power to Platform, 115V	3
28236	Warning – Improper Operation	1
30080	Instructions – Max Load, 500 lbs / 227 kg	1
31060	Danger – Tip-over Hazard, Limit Switch	4
31788	Danger – Explosion/Burn Hazard	1
40434	Label – Lanyard Anchorage Point	8
43595	Danger – Tip-over Hazard, Tires	4
44981	Label – Air Line to Platform (option)	2
44986	Instructions – Max Manual Force, 90 lbs / 400 N	1
52865	Warning – Annual Inspection Record	1
52966	Cosmetic – 4 x 2	1
52967	Cosmetic – 4 x 4	1
65278	Caution – No Step	4
72053	Label – Circuit Breaker 30 amp	1
72168	Label – Starter Battery	1
72169	Label – Controls Battery	1
72875	Warning – Pipe Cradle (option)	2
82237	Danger – Electrocutation Hazard (option)	4
82268	Cosmetic – Genie Z-80/60	1
82269	Ground Control Panel	1
82281	Platform Control Panel	1

Part No.	Decal Description	Qty
82296	Danger/Label – Tire Specifications, Foam	4
82312	Cosmetic – Z-80/60	1
82366	Label – Chevron Rando	1
82422	Label – Lights	1
82862	Danger – Fire Extinguisher, Welder (option)	1
97576	Instructions – Deutz Engine Specs, BF4L2011	1
97579	Danger – Tip-over Welder (option)	1
97602	Warning – Explosion Hazard	1
97758	Instructions – Perkins Engine Specs, 804C-33	1
97815	Label – Lower Mid-rail	1
97875	Warning – Weld Line to Platform	2
111878	Label – Fuse and Relay Panel	1
111896	Instructions – Continental Engine Specs	1
114166	Label – Transport Diagram	1
114258	Danger – Explosion Hazard	1
114389	Danger – Safety Rules	2
114390	Danger – Electrocutation Hazard	2
122066	Label – Fuse and Relay Panel	1
122627	Instructions – Perkins Engine Specs	1
128953	Instructions – Deutz Engine Specs	1
133163	Label – Function Override (Aircraft Protection Package)	1
133177	Danger/Label – Tire Specifications, Solid Rubber	4
133236	Danger – Tip-over Hazard	1
133278	Label – Low Sulfur Fuel (diesel models)	1
133400	Label – Wheel Load	4
161084	Label – Deutz, ROW	1
230986	Ground Control Panel	1
226518	Instructions – Operating Instructions	2
233131	Platform Control Panel	1
822820	Ground Control Panel	1
1258972	Instructions – Perkins Engine Specs, 404D-22T	1
1263543	Warning – Compartment Access	2
1263544	Bypass Key Switch	1
1263545	Instructions – Bypass Key Switch	1
1271397	Instructions – GM 3.0L Engine	1
1272242	Label – Machine Registration/Owner Transfer	1
1272808	Label – No Step	3

 Shading indicates decal is hidden from view, i.e. under covers

Inspections

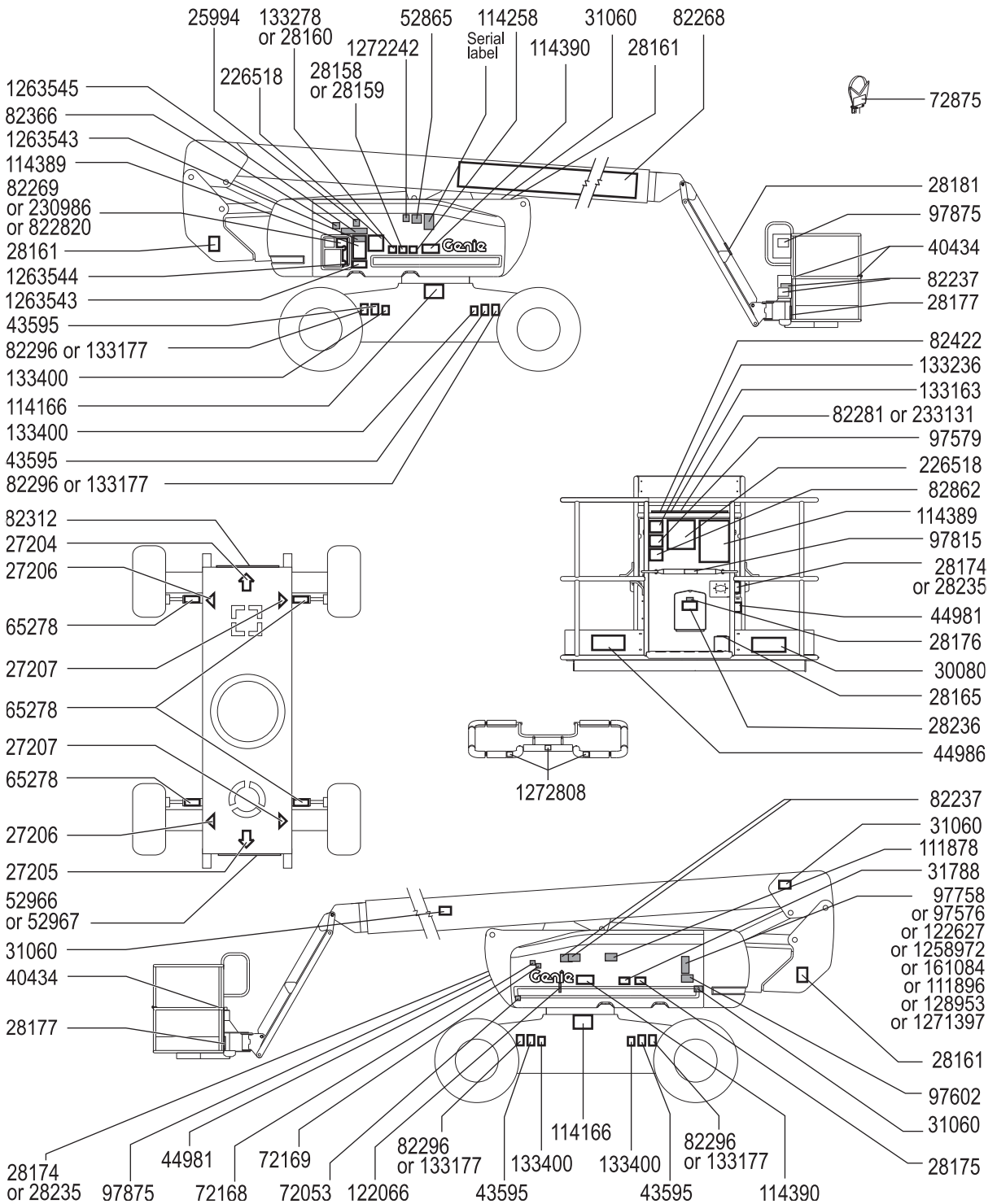

Operating Instructions



Do Not Operate Unless:

- You learn and practice the principles of safe machine operation contained in this operator's manual.
 - 1 Avoid hazardous situations.
 - 2 Always perform a pre-operation inspection.
 - 3 Always perform function tests prior to use.
 - 4 Inspect the workplace.
 - 5 **Only use the machine as it was intended.**

Fundamentals

The Operating Instructions section provides instructions for each aspect of machine operation. It is the operator's responsibility to follow all the safety rules and instructions in the operator's, safety and responsibilities manuals.

Using the machine for anything other than lifting personnel, along with their tools and materials, to an aerial work site is unsafe and dangerous.

Only trained and authorized personnel should be permitted to operate a machine. If more than one operator is expected to use a machine at different times in the same work shift, they must all be qualified operators and are all expected to follow all safety rules and instructions in the operator's, safety and responsibilities manuals. That means every new operator should perform a pre-operation inspection, function tests, and a workplace inspection before using the machine.

Operating Instructions

Starting the Engine

- 1 At the ground controls, turn the key switch to the desired position.
- 2 Be sure both ground and platform control red Emergency Stop buttons are pulled out to the on position.

Gasoline/LPG models

- 1 Choose fuel by moving the fuel select switch to the desired position.
- 2 Move the engine start toggle switch to either side. If the engine fails to start or dies, the restart delay will disable the start switch for 3 seconds.



All models

If the engine fails to start after 15 seconds of cranking, determine the cause and repair any malfunction. Wait 60 seconds before trying to start again.

In cold conditions, -6°C and below, warm the engine for 5 minutes before operating to prevent hydraulic system damage.

In extreme cold conditions, -18°C and below, machines should be equipped with optional cold start kits. Attempting to start the engine when temperatures are below -18°C may require the use of a booster battery.

Gasoline/LPG models: In cold conditions, -6°C and below, the machine should be started on gasoline and warmed for 2 minutes, then switched to LPG. Warm engines can be started on LPG.

Diesel models

- 1 Activate the glow plugs. Push the button or move the switch.
- 2 Start the engine. Push the button or move the switch. If the engine fails to start or dies, the restart delay with disable the start switch for 3 seconds.

Operating Instructions

Emergency Stop

Push in the red Emergency Stop button to the off position at the ground controls or the platform controls to stop all machine functions and turn the engine off.

Repair any function that operates when either red Emergency Stop button is pushed in.

Selecting and operating the ground controls will override the platform red Emergency Stop button.

Emergency Controls

Use emergency power if the primary power source (engine) fails.

- 1 Turn the key switch to ground or platform control.
- 2 Pull out the red Emergency Stop button to the on position.
- 3 Press down the foot switch when using the controls from the platform.
- 4 Activate the emergency controls. Move and hold the switch or push and hold the button. Activate each function control handle, switch or button.



The drive function will not operate with emergency power.

Operation from Ground

- 1 Turn the key switch to ground control.
- 2 Pull out the red Emergency Stop button to the on position.
- 3 Gasoline/LPG models: Choose fuel source.
- 4 Start the engine.

To Position Platform

- 1 Push and hold a function enable/speed select button.



- 2 Push the appropriate function button according to the markings on the control panel.

Drive and steer functions are not available from the ground controls.

Operating Instructions

Operation from Platform

- 1 Turn the key switch to platform control.
- 2 Pull out both ground and platform red Emergency Stop buttons to the on position.
- 3 Gasoline/LPG models: Choose fuel source.
- 4 Start the engine. Do not press down the foot switch when starting the engine.

To Position Platform

- 1 Press down the foot switch.
- 2 Slowly move the appropriate function control handle or toggle switch or press the appropriate button according to the markings on the control panel.

To Steer

- 1 Press down the foot switch.

Models with 4 wheel steer:

- 2 Select steer mode. Press the button or move the switch. The indicator light next to the current steer mode will be on.



All models:

- 3 Slowly move the drive control handle in the direction indicated by blue or yellow triangles OR press the thumb rocker switch located on top of the drive control handle.

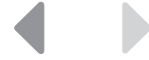

Use the color-coded direction arrows on the platform controls and the drive chassis to identify the direction the wheels will turn.

To Drive

- 1 Press down the foot switch.
- 2 Increase speed: Slowly move the drive/steer control handle in the direction indicated by the blue or yellow arrows.



Decrease speed: Slowly move the drive/steer control handle toward center.

Stop: Return the drive/steer control handle to center or release the foot switch.

Use the color-coded direction arrows on the platform controls and the drive chassis to identify the direction the machine will travel.

Machine travel speed is restricted when the platform is raised or extended.

Operating Instructions

▲ Driving on a slope

Determine the uphill, downhill and side slope ratings for the machine and determine the slope grade.



Maximum slope rating, platform downhill (gradeability):

2WD: 30% (17°)
4WD: 45% (24°)



Maximum slope rating, platform uphill:

2WD: 15% (9°)
4WD: 35% (19°)



Maximum side slope rating: 25% (14°)

Note: Slope rating is subject to ground conditions with one person in the platform and adequate traction. Additional platform weight may reduce slope rating. The term gradeability applies to the counterweight uphill configuration only.

Be sure the boom is below horizontal and the platform is between the circle-end (yellow arrow) wheels.

Select machine on incline drive setting. Move the switch or push the button until the light next to the machine on incline symbol is on.

To determine the slope grade:

Measure the slope with a digital inclinometer OR use the following procedure.

You will need:

- carpenter's level
- straight piece of wood, at least 1 m long
- tape measure

Lay the piece of wood on the slope.

At the downhill end, lay the level on the top edge of the piece of wood and lift the end until the piece of wood is level.

While holding the piece of wood level, measure the vertical distance from the bottom of the piece of wood to the ground.

Divide the tape measure distance (rise) by the length of the piece of wood (run) and multiply by 100.

Example:



Piece of wood = 3.6 m

Run = 3.6 m

Rise = 0.3 m

$0.3 \text{ m} \div 3.6 \text{ m} = 0.083 \times 100 = 8.3\% \text{ grade}$

If the slope exceeds the maximum uphill, downhill or side slope rating, then the machine must be winched or transported up or down the slope. See Transport and Lifting section.

Operating Instructions

Drive Enable

Light on indicates that the boom has moved just past either circle-end wheel and the drive function is turned off.

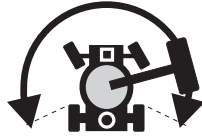

To drive, push the drive enable button or move the drive enable switch to either side and slowly move the drive/steer control handle off center.

If the drive/steer control handle is not moved within two seconds of activating the drive enable, the drive function will not operate. Release and activate the drive enable again.

Be aware that the machine may move in the opposite direction that the drive and steer controls are moved.

Always use the color-coded direction arrows on the platform controls and the drive chassis to identify the direction the machine will travel.

Generator (if equipped)

To operate the generator, press the generator button or move the switch. The indicator light will come on the engine will continue to run.

Plug a power tool into the power to platform GFCI outlet.

To turn off the generator, press the generator button or move the switch. The indicator light will turn off.

Engine Idle Select (rpm)

Select engine idle (rpm). Push the button or move the switch. The indicator light next to the current setting will be on.



- Rabbit and foot switch symbol: foot switch activated high idle
- Turtle symbol: low idle
- Rabbit symbol: high idle

Check Engine Light (if equipped)



Light on and engine stopped: Tag the machine and remove from service.

Light on and engine still running: Contact service personnel within 24 hours.

Platform Overload Indicator Light



Light flashing indicates the platform is overloaded. The engine will stop and no functions will operate.

Remove weight from the platform until the light goes off and then restart the engine.

Operating Instructions

Operating Envelope Indicator Lights

The operating envelope indicator lights will come on to notify the operator that a function has been interrupted and/or an action is required by the operator.

Lower Primary Boom indicator light flashing: Lower the primary boom until the indicator light is off.

Machine Not Level indicator light flashing: The tilt alarm will be sounding when this light is flashing. Move the machine to a firm, level surface.

Platform Not Level indicator light flashing: The tilt alarm will be sounding when this light is flashing. The Platform Level toggle switch will only work in the direction that will level the platform. Level the platform until the indicator light is off.



Platform Level Recovery

- 1 Press down the foot switch.
- 2 Push and hold the platform level recovery switch up.
- 3 Move the platform level switch in the desired direction.

Note: The platform level switch will only work in the direction that will return the platform to a level position.

Note: From +/-10 degrees of platform level up to +/-14.9 degrees the platform can still be recovered from the ground controls or by using the platform level recovery toggle switch in the procedure above. Once the platform level reaches +/-15 degrees the only way to recover is to use the Service/Recovery key switch on the side of the ground controls to activate Recovery Mode.

Platform Out of Level (P22 code)

Bypass key position to be used to level the platform if ground control display shows platform out of level (P22) and platform level controls do not work.

To operate:

- 1 Turn the engine off.
- 2 Turn the main key switch to ground control. Remove the key from the main key switch and insert the key into the bypass/recovery key switch.
- 3 Turn the bypass/recovery key switch to the bypass position.
- 4 Using emergency power, operate the platform level button to level the platform.
- 5 Turn the bypass/recovery key switch to the run position.
- 6 Remove the key from the bypass/recovery key switch and insert the key into the main key switch.
- 7 Push in and then pull out the red Emergency Stop button.
- 8 If the P22 code is still visible, tag and remove the machine from service until the fault has been corrected by a qualified service technician.



Platform Out of Level (Platform Level > 15 Degrees Fault)

If ground control display shows PLATFORM LEVEL > 15 DEGREES FAULT and the platform level controls do not work, the machine will need to be recovered by trained and authorized personnel or a qualified service technician.

Operating Instructions

Drive Speed Select



- Machine on incline symbol: Low range operation for inclines or rough terrain
- Machine on level surface symbol: High range operation for maximum drive speed

Machine Not Level Indicator Light (if equipped)



Light on indicates machine is not level. The tilt alarm will be sounding when this light is on. Move the machine to a firm level surface.

Machine Malfunction Indicator Light



Light on indicates all functions have stopped.

- 1 Push in and then pull out the red Emergency Stop button.
- 2 Lower and retract the boom.
- 3 Tag the machine and remove from service. Functions will not operate.

Engine Shut-down indicator light (if equipped)



Light on: Tag and remove the machine from service.

Out of Operational Envelope Recovery

If all functions stop operating, you may have exceeded the operational envelope. A trained operator on the ground will need to lower the platform from the ground controls. Please see the Service Bypass / Recovery Key Switch section in the service manual.

LCD Screen (if equipped)

The LCD screen displays hour meter, voltage, oil pressure and coolant temperature. The screen also displays fault codes and other service information.

Perkins Engine

Machines equipped with Perkins 404TF-22 Diesel engines have a regeneration mode that should run automatically when needed.

LCD will display REGEN FORCED and WARNING HIGH EXHAUST SYSTEM TEMP when the regeneration mode is running. No service required.

Stopping the Engine

Push in the red Emergency Stop button and turn the key switch to the off position.

Aircraft Protection Package (if equipped)



If the platform bumper comes into contact with an object, the machine will shut down and no functions will operate.

- 1 Start the engine.
- 2 Press down the foot switch.
- 3 Move and hold the aircraft protection override switch.
- 4 Move the appropriate function control handle or toggle switch to move the machine away from aircraft components.

Operating Instructions

Pipe Cradle Instructions

The pipe cradle assembly consists of 2 pipe cradles positioned at either side of the platform and mounted to the guardrails with U-bolts.

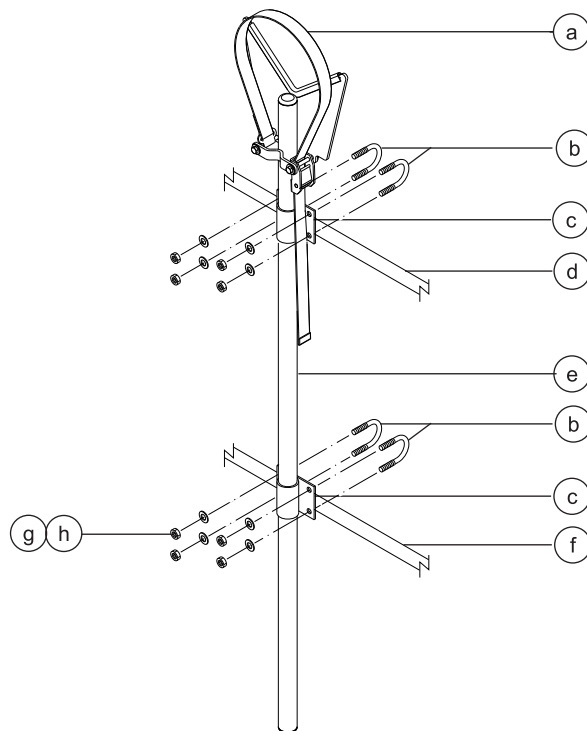

- a strap
- b U-bolts
- c pipe cradle mount
- d upper platform railing
- e pipe cradle weldment
- f middle platform railing
- g flat washers
- h nylock nuts

Observe and Obey:

- Pipe cradles must be installed on the inside of the platform.
- Pipe cradles must not obstruct the platform controls or the platform entrance.
- The bottom of the pipe cradle tube must rest on the platform floor.
- Be sure the platform is level before installing a pipe cradle.

Pipe Cradle Installation

- 1 Install a pipe cradle on each side of the platform. Refer to the illustration on the left. Make sure the bottom of the pipe cradle tube rests on the platform floor.
- 2 Install two U-bolts from the outside of the platform rails through each pipe cradle mount.
- 3 Secure each U-bolt with 2 washers and 2 nuts.

Operating Instructions

Pipe Cradle Operation

- 1 Be sure the pipe cradle assembly and installation instructions have been followed properly and that the pipe cradles are secured to the platform railings.
 - 2 Place the load so that it rests in both pipe cradles. The length of the load should be parallel with the length of the platform.
 - 3 Center the load in the pipe cradles.
 - 4 Secure the load to each pipe cradle. Pass the nylon strap over the load. Depress the buckle and slide the strap through. Tighten the strap.
 - 5 Gently push and pull on the load to make sure the pipe cradles and load are secure.
 - 6 Keep the load secured when the machine is moving.
- ▲ Tip-over hazard. The weight of the pipe cradle assembly and the load in the pipe cradles will reduce the rated platform capacity of the machine and must be factored into the total platform load.
- ▲ Tip-over hazard. The weight of the pipe cradle assembly and the load in the pipe cradles may limit the maximum number of occupants in the platform.

Maximum Pipe Cradle Capacity

All models	90.7 kg
Pipe Cradle Assembly Weight	9.5 kg

Panel Cradle Assembly

- 1 Apply the warning decal to the front of each panel cradle (if needed).
- 2 Install rubber bumper 1 in the panel cradle base. See the illustration.
- 3 Secure the bumper with 2 high profile lock nuts and 2 washers.

Panel Cradle Installation

- 1 Insert the hook piece through the slots in the panel cradle base.
- 2 Hook the panel cradle to the bottom platform tube in the desired location.
- 3 Install rubber bumper 2 through the panel cradle base and the hook piece. See the illustration.
- 4 Secure with 2 low profile lock nuts.
- 5 If the panel cradle is installed at a platform floor support tube, insert the U-bolt through the floor, around the tube and into the panel cradle base.
- 6 Secure the U-bolt with 2 nuts and 2 washers. Proceed to step 9.
- 7 If the panel cradle is not installed at a platform floor support tube, use the aluminum tube provided.
- 8 Place the tube between the panel cradle and the platform floor. Insert the U-bolt through the floor, around the tube and into the panel cradle base.
- 9 Repeat above for the second set of parts.

Operating Instructions

Installation of Padding

- 1 Install the 2 pieces of padding on the platform rails. Position the padding to protect the panels from contact with the platform rails.

Installation of Strap

- 1 Open the clamp and install it around a vertical platform rail tube.
- 2 Insert a bolt with a washer through one side of the clamp.
- 3 Install the strap assembly end plate onto the bolt.
- 4 Insert the bolt through the other side of the clamp.
- 5 Secure with a washer and a nut. Do not over-tighten. The strap assembly end plate should be able to slide on the platform rail.

Panel Cradle Operation

- 1 Secure both panel cradles to the platform.
- 2 Place the load so that it rests in both panel cradles.
- 3 Center the load on the platform.
- 4 Secure the load to the platform using the strap. Tighten the strap.

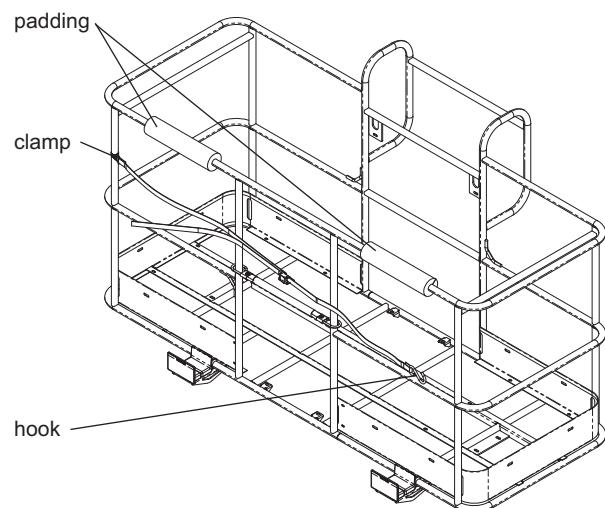
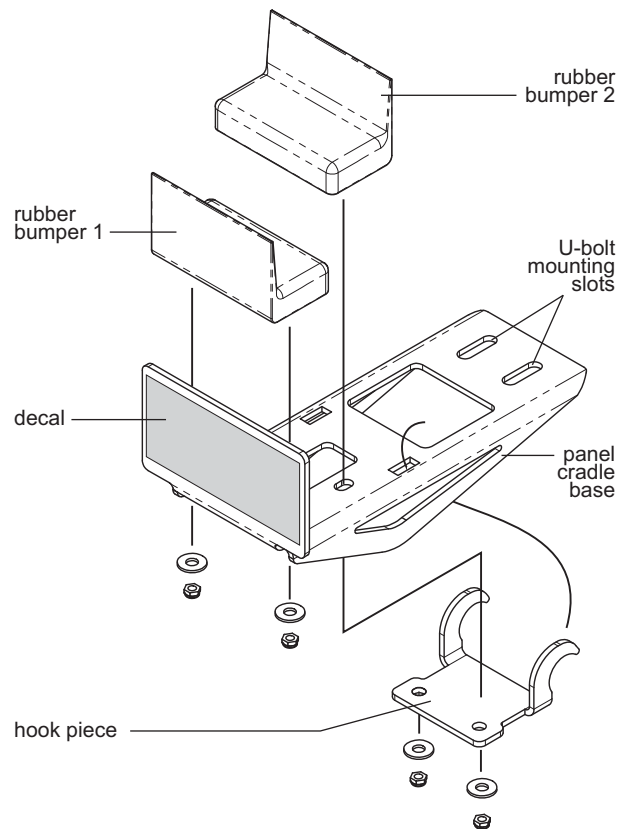

Operating Instructions

After Each Use

- 1 Select a safe parking location—firm level surface, clear of obstruction and traffic.
- 2 Retract and lower the boom to the stowed position.
- 3 Rotate the turntable so that the boom is between the non-steer wheels.
- 4 Turn the key switch to the off position and remove the key to secure from unauthorized use.

Transport and Lifting Instructions



Observe and Obey:

- ☑ Genie provides this securement information as a recommendation. Drivers are solely responsible for making sure machines are properly secured and the correct trailer is selected pursuant to US Department of Transportation regulations, other localized regulations, and their company policy.
- ☑ Genie customers needing to containerize any lift or Genie product should source a qualified freight forwarder with expertise in preparing, loading and securing construction and lifting equipment for international shipment.
- ☑ Only qualified aerial lift operators should move the machine on or off the truck.
- ☑ The transport vehicle must be parked on a level surface.
- ☑ The transport vehicle must be secured to prevent rolling while the machine is being loaded.
- ☑ Be sure the vehicle capacity, loading surfaces and chains or straps are sufficient to withstand the machine weight. Genie lifts are very heavy relative to their size. See the serial label for the machine weight.

- ☑ Be sure the turntable is secured with the turntable rotation lock before transporting. Be sure to unlock the turntable for operation.
- ☑ Do not drive the machine on a slope that exceeds the uphill, downhill or side slope rating. See Driving on a Slope in the Operating Instructions section.
- ☑ If the slope of the transport vehicle bed exceeds the maximum slope rating, the machine must be loaded and unloaded using a winch as described in the brake release operation.

Free-wheel Configuration for Winching

Chock the wheels to prevent the machine from rolling.

Release the non-steer wheel brakes by turning over the drive hub disconnect caps.

Be sure the winch line is properly secured to the drive chassis tie points and the path is clear of all obstructions.

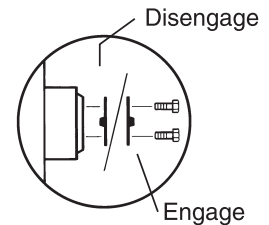

Reverse the procedures described to re-engage the brakes.

Towing the Genie Z-80/60 is not recommended. If the machine must be towed, do not exceed 3.2 km/h.

Transport and Lifting Instructions

Securing to Truck or Trailer for Transit

Always use the turntable rotation lock pin each time the machine is transported.

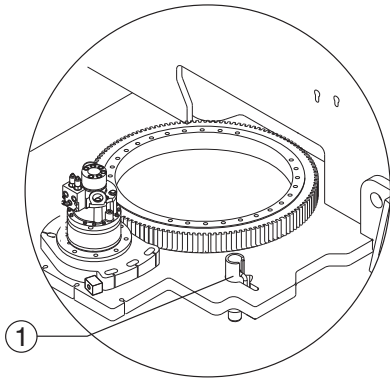

1 Turntable rotation lock pin

Turn the key switch to the off position and remove the key before transporting.

Inspect the entire machine for loose or unsecured items.

Securing the Chassis

Use chains of ample load capacity.

Use a minimum of 5 chains.

Adjust the rigging to prevent damage to the chains.

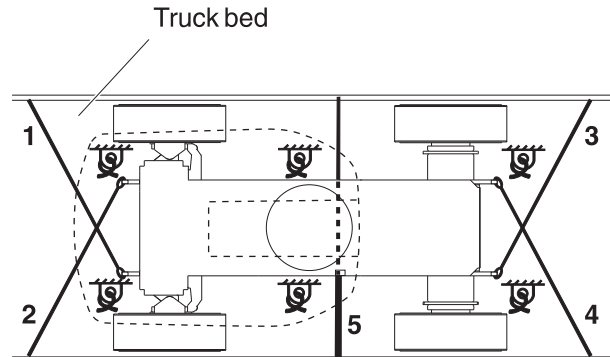

Securing the Platform

Make sure the jib and platform are in the stowed position.

Place a block under the platform rotator. Do not allow the block to contact the platform cylinder.

Secure the platform with a nylon strap placed through the lower platform support. Do not use excessive downward force when securing the boom section.

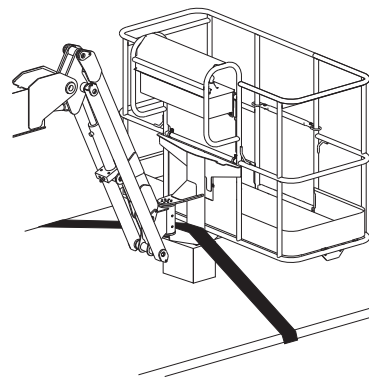

Transport and Lifting Instructions



Observe and Obey:

- ☑ Only qualified riggers should rig and lift the machine.
- ☑ Be sure the crane capacity, loading surfaces and straps or lines are sufficient to withstand the machine weight. See the serial label for the machine weight.

Lifting Instructions

Fully lower and retract both the primary and secondary booms. Remove all loose items on the machine.

Rotate the turntable 90 degrees.

Determine the center of gravity of your machine using the picture on this page.

Attach the rigging only to the designated lifting points on the machine.

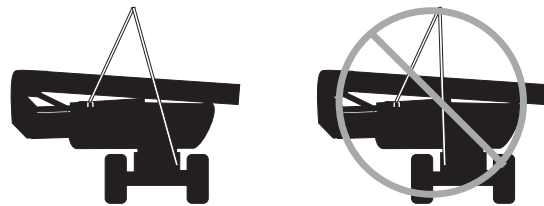

Attach the rigging to the 2 chassis lifting points farthest from the turntable lifting point.

Adjust the rigging to prevent damage to the machine and to keep the machine level.

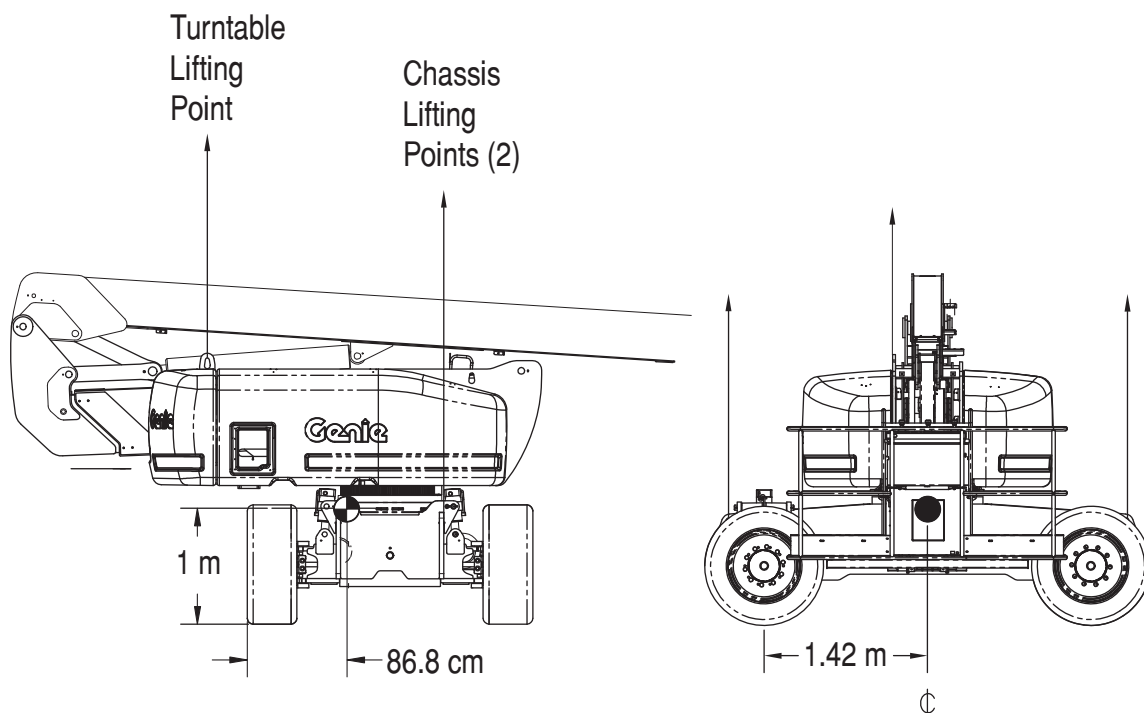

Maintenance



Observe and Obey:

- ☑ Only routine maintenance items specified in this manual shall be performed by the operator.
- ☑ Scheduled maintenance inspections shall be completed by qualified service technicians, according to the manufacturer's specifications and the requirements specified in the responsibilities manual.
- ☑ Use only Genie approved replacement parts.

Maintenance Symbols Legend

The following symbols have been used in this manual to help communicate the intent of the instructions. When one or more of the symbols appear at the beginning of a maintenance procedure, it conveys the meaning below.



Indicates that tools will be required to perform this procedure.



Indicates that new parts will be required to perform this procedure.



Indicates that a cold engine is required before performing this procedure.

Check the Engine Oil Level



Maintaining the proper engine oil level is essential to good engine performance and service life. Operating the machine with an improper oil level can damage engine components.

Note: Check the oil level with the engine off.

- 1 Check the oil level dipstick. Add oil as needed.

Perkins 804C-33 Engine

Oil type	15W-40
Oil type - cold conditions	5W-40

Perkins 804D-33 Engine

Oil type	15W-40
Oil type - cold conditions	5W-40

Perkins 404D-22T Engine

Oil type	15W-40
Oil type - cold conditions	5W-40

Continental TME27 Engine

Oil type	15W-40
Oil type - cold conditions	5W-40

Deutz BF4L Engine

Oil type	15W-40
Oil type - cold conditions	5W-30

GM 3.0L I4 Engine

Oil type	5W-30
Oil type - cold conditions	5W-30

Maintenance

Check the Hydraulic Oil Level



Maintaining the hydraulic oil at the proper level is essential to machine operation. Improper hydraulic oil levels can damage hydraulic components. Daily checks allow the inspector to identify changes in oil level that might indicate the presence of hydraulic system problems.

- 1 Be sure that the boom is in the stowed position.
- 2 Visually inspect the sight gauge located on the side of the hydraulic oil tank.
- ⊙ Result: The hydraulic oil level should be within the top 5 cm of the sight gauge.
- 3 Add oil as needed. Do not overfill.

Hydraulic oil specifications

Hydraulic oil type	Chevron Rando HD equivalent
--------------------	-----------------------------

Check the Batteries



Proper battery condition is essential to good machine performance and operational safety. Improper fluid levels or damaged cables and connections can result in component damage and hazardous conditions.

- ▲ Electrocuting hazard. Contact with hot or live circuits may result in death or serious injury. Remove all rings, watches and other jewelry.
 - ▲ Bodily injury hazard. Batteries contain acid. Avoid spilling or contacting battery acid. Neutralize battery acid spills with baking soda and water.
- 1 Put on protective clothing and eye wear.
 - 2 Be sure that the battery cable connections are tight and free of corrosion.
 - 3 Be sure that the battery hold-down brackets are in place and secure.

Note: Adding terminal protectors and a corrosion preventative sealant will help eliminate the corrosion on the battery terminals and cables.

Maintenance

Check the Engine Coolant Level – Liquid Cooled Models



Maintaining the engine coolant at the proper level is essential to engine service life. Improper coolant level will affect the engine's cooling capability and damage engine components. Daily checks will allow the inspector to identify changes in coolant level that might indicate cooling system problems.

- 1 Check the fluid level in the coolant recovery tank. Add fluid as needed.
- ⊕ Result: The fluid level should be in the NORMAL range.
 - ▲ Bodily Injury Hazard. Fluids in the radiator are under pressure and extremely hot. Use caution when removing cap and adding fluids.

Check the Tire Pressure



Note: This procedure does not need to be performed on machines equipped with foam-filled tires.

- ▲ Bodily injury hazard. An over-inflated tire can explode and may cause death or serious injury.
- ▲ Tip-over hazard. Do not use temporary flat tire repair products.

To safeguard maximum stability, achieve optimum machine handling and minimize tire wear, it is essential to maintain proper pressure in all air-filled tires.

- 1 Check each tire with an air pressure gauge. Add air as needed.

High flotation tire pressure

5.5 bar

Maintenance

Diesel Fuel Requirements



Satisfactory engine performance is dependent on the use of a good quality fuel. The use of a good quality fuel will give the following result: long engine life and acceptable exhaust emissions levels.

Minimum diesel fuel requirements for each engine are listed below.

Perkins 804C-33 Engine

Fuel Type	Low Sulfur Diesel (LSD)
-----------	-------------------------

Perkins 804D-33 Engine

Fuel Type	Low Sulfur Diesel (LSD)
-----------	-------------------------

Perkins 404D-22T Engine

Fuel Type	Low Sulfur Diesel (LSD)
-----------	-------------------------

Continental TME27 Engine

Fuel Type	Low Sulfur Diesel (LSD)
-----------	-------------------------

Deutz BF4L Engine

Fuel Type	Low Sulfur Diesel (LSD)
-----------	-------------------------

Scheduled Maintenance

Maintenance performed quarterly, annually and every two years must be completed by a person trained and qualified to perform maintenance on this machine according to the procedures found in the service manual for this machine.

Machines that have been out of service for more than three months must receive the quarterly inspection before they are put back into service.

Specifications

Model	Z-80/60
Height, working maximum	25.6 m
Height, platform maximum	23.8 m
Height, stowed maximum	3 m
Horizontal reach, maximum	18.3 m
Width	2.5 m
Length, stowed	11.3 m
Length, stowed for transport	9.1 m
Maximum load capacity	227 kg
Maximum wind speed	12.5 m/s
Wheelbase	2.84 m
Ground clearance	30 cm
Turning radius (outside)	
2 wheel steer	7.5 m
4 wheel steer	4.6 m
Turning radius (inside)	
2 wheel steer	4.4 m
4 wheel steer	2.1 m
Turntable rotation (degrees)	Continuous
Turntable tailswing, secondary boom lowered	2.24 m
Turntable tailswing, secondary boom raised	1.17 m
Controls	12V DC proportional
Platform dimensions, 5 foot (length x width)	150 x76 cm
Platform dimensions, 6 foot (length x width)	182 x 76 cm
Platform dimensions, 8 foot (length x width)	244 x 91 cm
Platform leveling	self-leveling
Platform rotation	160°
AC outlet in platform	standard
Hydraulic pressure, maximum (boom functions)	220 bar
System voltage	12V
Tire size	18-625, 16 ply FF
Tire size, solid rubber	41 X 17-24 F2A
Total vibration value to which the hand/arm system is subjected does not exceed 2.5 m/s ² .	

Highest root mean square value of weighted acceleration to which the whole body is subjected does not exceed 0.5 m/s².

Weight	17,010 kg
(Machine weights vary with option configurations. See serial label for specific machine weight.)	
Fuel tank capacity, diesel	132 liters
Fuel tank capacity, gasoline	114 liters

Maximum slope rating, stowed position, 4WD

Platform downhill	45% 24°
Platform uphill	35% 19°
Side slope	25% 14°

Note: Slope rating is subject to ground conditions with one person in the platform and adequate traction. Additional platform weight may reduce slope rating.

Maximum allowed inclination of the chassis 4.5°

Drive speeds (foam-filled tires)

Drive speed, stowed	4.8 km/h 12.2 m/9.1 sec
Drive speed, raised or extended – all models	1.1 km/h 12.2 m/40 sec

Airborne noise emissions

Sound pressure level at ground workstation	85 dBA
Sound pressure level at platform workstation	74 dBA
Guaranteed sound power level	106 dBA

Floor loading information

Tire load maximum	10,206 kg
Tire contact pressure	9.1 kg / cm ² 896 kPa
Occupied floor pressure	1841 kg / m ² 18.05 kPa

Note: Floor loading information is approximate and does not incorporate different option configurations. It should be used only with adequate safety factors.

Continuous improvement of our products is a Genie policy. Product specifications are subject to change without notice or obligation.

Specifications

Z-80/60 Range of Motion

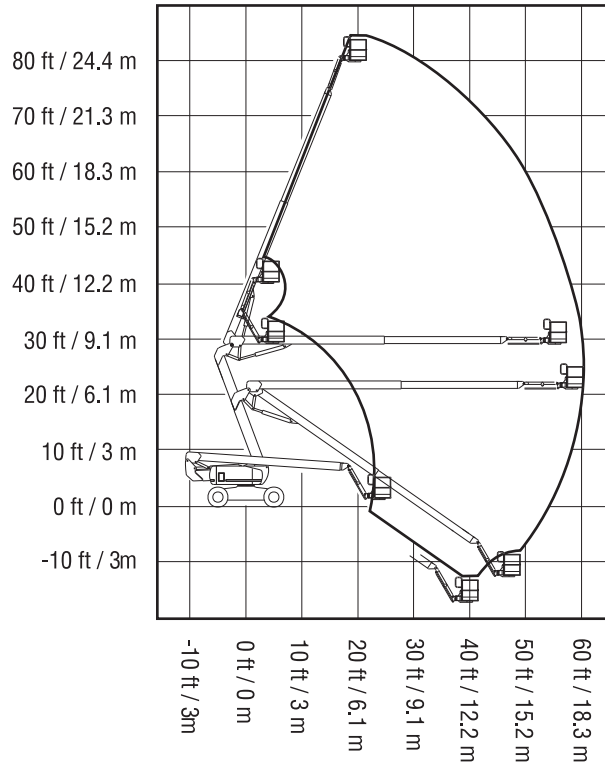

www.genielift.com

Distributed By: